



PowerFlex Low Voltage Drives

Powerful Performance. Flexible Control.



Allen-Bradley

by ROCKWELL AUTOMATION

What's Inside

Topic	Page
Powerful Performance and Flexible Control	3
Simplified Drive Configuration and Programming	4
Safety Solutions	4
Line and Load Options	6
Select a PowerFlex Low Voltage Drive	7
PowerFlex 4M AC Drives	17
PowerFlex 523 AC Drives	24
PowerFlex 525 AC Drives	27
PowerFlex 527 AC Drives	30
PowerFlex 70 AC Drives	33
PowerFlex 700 AC Drive	36
PowerFlex 753 AC Drives	37
PowerFlex 755 AC Drives	42
PowerFlex 755TL/TR AC Drives	47
PowerFlex DC Drives	55

What's New

Corrosive Gas Protection

Facilities with corrosive gases are constantly addressing the threat of early equipment failure and have had very few options to combat this, until now. Today the PowerFlex 755TL, TR, and TM drives have what is required to combat corrosion beyond today's commonly used industry-standard tests.

Through testing in our customers' corrosive environments, and development in our own advanced chemistry lab, we have discovered a solution to help hardware withstand exposure to corrosive gases.

We have applied this newly developed corrosive gas protection (XT) to the product design of our low harmonic, regenerative, and common bus PowerFlex drives. This new corrosive gas protection offers greater defense than traditional conformal coating does on its own. Combined with several additional design enhancements, these drives provide improved performance in environments where corrosive gases are prevalent.

Revision 10 Firmware

This release of firmware includes the following feature additions:

- CIP Security: Secure communications with EtherNet/IP™ network protocol. Provides:
 - Authentication-helps prevent unauthorized devices from establishing connections.
 - Integrity-helps prevent tampering or modification of communications
 - Confidentiality-helps prevent snooping or disclosure of data
- CIP object for predictive maintenance: Improved software user interface for implementing predictive maintenance features. The Predictive Maintenance information in the product will no longer be available via parameters, instead it is part of an object to simplify data access into control system for faceplate, storing, advanced analytics, and dashboard usage. Additionally, the units of measurement are changing from percent of life to hours.

- Synchronous reluctance motor control: Now use frequency control modes (VHz and SVC) of PowerFlex 755TL, TR, and TM drives with synchronous reluctance motors.

This release of firmware also includes enhancements to existing features including energy pause for common bus inverters, reduced carrier frequency at low speed, and others.

T-Link Option Card

The T-Link option card for PowerFlex 755T Drives enables high-speed drive to drive communication.

High-speed drive to drive communication simplifies or eliminates logic and hardware necessary to synchronize control between drives. It could also simplify commissioning by reducing the time to tune follower drives by directly controlling torque or velocity outputs from the leader drive.

This functionality is well suited for the following scenarios:

- When synchronization is needed between drives
- When multiple motors are coordinated to simulate mechanically coupled system (Electronic line-shaft applications)
- When multiple motors are rigidly coupled (Load-sharing applications)
- When there is single leader with multiple followers (Rotary table applications)

Industry Applications:

- Mining dredger, dragline, and hoist (velocity regulator leader with torque follower when connected to single shaft)
- Metals wire drawing, levelers, flying shear, and low-twist rod mill
- Automotive test stands, dynes, and wheel followers
- Commercial printing operations

PowerFlex 755T Drives Configured to Order

Our configured to order drives are factory delivered for PowerFlex 755TL, TR, and TM drives in frames 5...12. Packaging options include NEMA Type 1 and 12 enclosures.

Options include:

- Input circuit breaker and/or fuses
- Door-mounted push buttons and selector switches
- Optional door-mounted HIM
- Output contactor and/or sine-wave (DV/DT) filter

Powerful Performance and Flexible Control

The Allen-Bradley® PowerFlex® family of AC and DC drives provide the benefits that matter most to you. Our focus on delivering a flexible portfolio designed to keep you connected to your operations and ultimately help improve productivity, helps you achieve the positive impact to be successful.

Optimize your application with a wide range of control technologies from open loop speed regulation to precise torque and speed control. In addition to industry standard motor control, the PowerFlex family offers unique control technologies that can provide you with even greater application flexibility.

FORCE™ Technology, is the original Allen-Bradley patented field-oriented Control that provides excellent low speed/zero speed performance and delivers accurate torque and speed regulation.

PowerFlex 755T drives offer TotalFORCE® Technology that builds on the original FORCE technology to deliver superior motor control through precise, adaptive control of torque, velocity, and position for electric motors.

EtherNet/IP connectivity supports seamless integration into the Logix environment. PowerFlex drives help you apply this open network by making connections simple with built-in or optional EtherNet/IP communication ports. EtherNet/IP connectivity provides the flexibility to support multiple network topologies - linear, star, or ring configurations. An added advantage is the support for Device Level Ring (DLR) functionality.

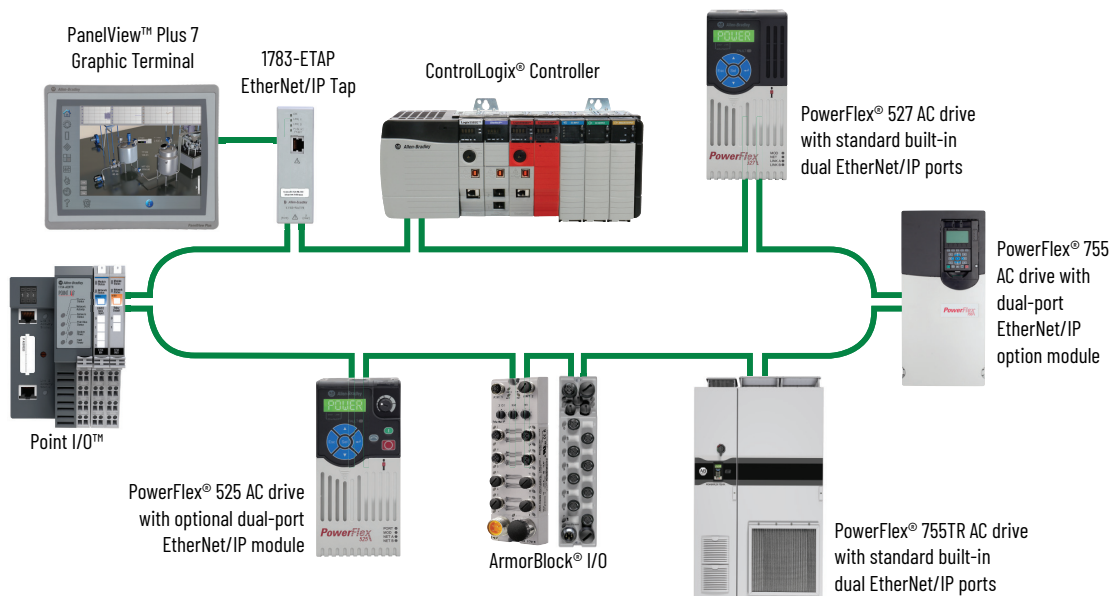

Drive Efficient Operations

Adjusting the speed of motors to exactly match the requirements of the application can help provide significant savings to your operations.

- Some PowerFlex drives offer an Economizer mode, which consists of sensorless vector control with an additional energy savings function. When steady-state speed is achieved, the economizer becomes active and automatically adjusts the drive output voltage based on the applied load.
- The option for permanent magnet motor control is available with many PowerFlex drives. Using permanent magnet motors can help improve energy efficiency and reduce related costs. The higher power density provided by permanent magnet motors often results in a motor size reduction while maintaining the same output torque.
- PowerFlex drives with regeneration capability help reduce energy consumption by delivering regenerative energy from motors back to the incoming power supply.

Simplified Drive Configuration and Programming

PowerFlex drives help make configuration and programming fast and uncomplicated with a choice of easy-to-use software packages and tools. Each tool is powerful and intuitive to help enhance your user experience and reduce your development time so you can deliver machines faster and more efficiently.

- The Human Interface Module (HIM) provides convenient configuration.
- Connected Components Workbench™ programming and configuration software leverages proven Rockwell Automation and Microsoft® Visual Studio® technologies for fast and easy drive configuration, controller programming, and integration with the HMI editor.
- PowerFlex drives are integrated within the Studio 5000® environment. Data associated with the drive is automatically generated to ease configuration and minimize the need to manually program the required parameters and tags.
- The PowerFlex 527 and 755 AC drives can be programmed using motion instructions in the Studio 5000 environment. These motion instructions are shared with Kinetix® servo drives, providing a common configuration, programming, and control experience for both types of drives.

Automatic Device Configuration

Automatic Device Configuration (ADC) lets Logix controllers detect a replaced PowerFlex drive and download all configuration parameters automatically, minimizing the need for manual reconfiguration. This feature helps to enhance productivity by facilitating reduced downtime. ADC can be used with PowerFlex drives that have a standard built-in EtherNet/IP port or drives using a dual-port EtherNet/IP option module.

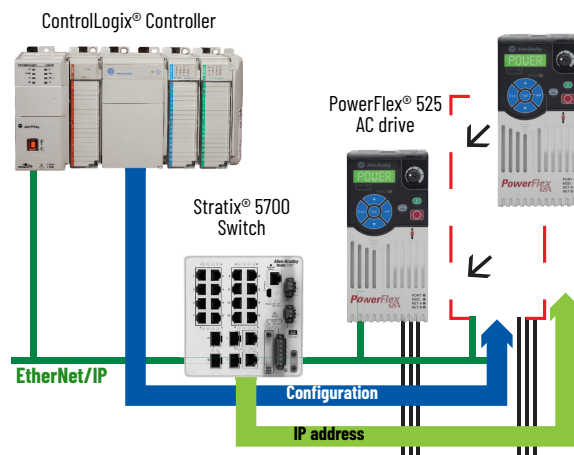

Safety Solutions

In the past, implementing safety solutions often meant sacrificing productivity. PowerFlex drives address productivity concerns by offering safety options that help protect your people and equipment while also reducing unplanned downtime.

Safety can be implemented with PowerFlex drives using either built-in features or add-on safety options. Choose from a hardwired configuration that is wired directly into the drive. Or use integrated safety that is delivered via EtherNet/IP with select drives.

Hardwired Safe Torque Off is ideal for safety-related applications that benefit from removal of rotational power to the motor without removing power from the drive. This functionality offers the benefit of quick startup after a demand on the safety system.

Integrated Safe Torque Off provides the same benefits and safety ratings as hardwired Safe Torque Off – plus the ability to simplify your machine design and minimize equipment redundancies.

- A single GuardLogix® controller can be used for both safety and standard control so that safety and non-safety functions share the same EtherNet/IP network
- Operators and maintenance personnel have visibility to all machine events including safety events. This enables a quick response that allows the machine to return to full production.

Hardwired Safe Torque Off

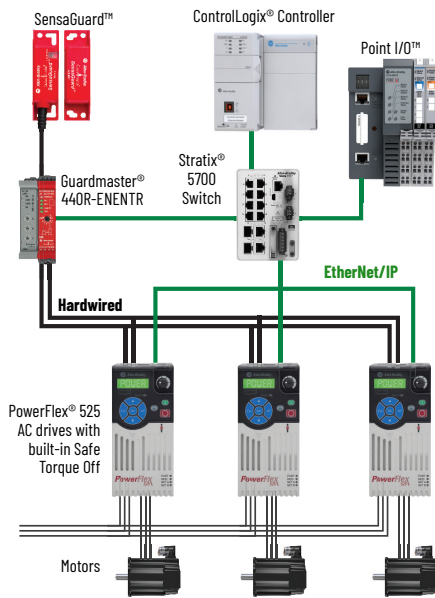

Integrated Safe Torque Off

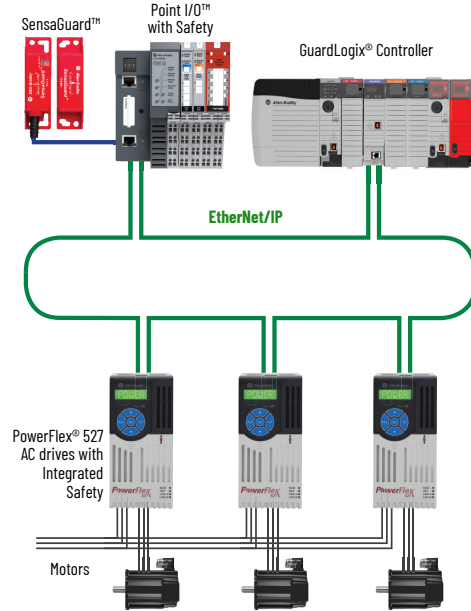

Safe Speed Monitor provides a solution for applications that can benefit from access to a safety zone while there is limited motion. It allows operators to perform some process or maintenance work without stopping the machine.

Integrated safety functions provide PowerFlex 755, 755TL, 755TR, and 755TM AC drives with advanced safety on an EtherNet/IP network. The option module uses safety instructions based on IEC 61800-5-2.

Drive-based safety instructions include:

- STO – Safe Torque Off
- SSI – Safe Stop 1

Controller-based safety functions include:

- SFX – Safety Feedback Interface
- SS1 – Safe Stop 1
- SS2 – Safe Stop 2
- SOS – Safe Operational Stop
- SLS – Safely-limited Speed
- SLP – Safely-limited Position
- SDI – Safe Direction
- SBC – Safe Brake Control

PowerFlex AC drives and Kinetix® servo drives use the same safety functions for a common, simplified user experience. When used as part of an integrated safety system that includes a GuardLogix 5580ES controller or Compact GuardLogix 5380ES controller, the integrated safety functions option module provides safety ratings up to and including SIL 3 and PLe Cat 4. Studio 5000 Logix Designer® application version 31 or later is also required.

Drive	Hardwired Safe Torque Off	Networked Safe Torque Off	Safe Speed Monitor	Network Integrated Safety Functions
PowerFlex 525	Built-in: SIL 2, PLd, CAT 3	—	—	—
PowerFlex 527	Built-in: SIL 3, PLe, CAT 3	Built-in: SIL 3, PLe, CAT 3	—	—
PowerFlex 70	Option: SIL 2, PLd, CAT 3	—	—	—
PowerFlex 753	Option: SIL 3, PLe, CAT 3	—	Option: SIL 3, PLe, CAT 4	—
PowerFlex 755	Option: SIL 3, PLe, CAT 3	Option: SIL 3, PLe, CAT 3	Option: SIL 3, PLe, CAT 4	Option: SIL 3, PLe, CAT 4
PowerFlex 755TL	Option: SIL 3, PLe, CAT 3	Option: SIL 3, PLe, CAT 3	Option: SIL 3, PLe, CAT 4	Option: SIL 3, PLe, CAT 4
PowerFlex 755TR	Option: SIL 3, PLe, CAT 3	Option: SIL 3, PLe, CAT 3	Option: SIL 3, PLe, CAT 4	Option: SIL 3, PLe, CAT 4
PowerFlex 755TM	Option: SIL 3, PLe, CAT 3	Option: SIL 3, PLe, CAT 3	Option: SIL 3, PLe, CAT 4	Option: SIL 3, PLe, CAT 4

Line and Load Options

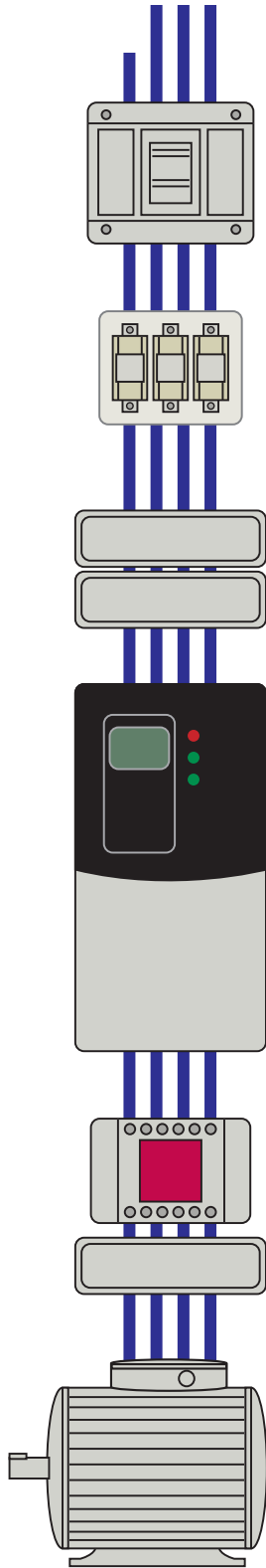

AC Supply Source

Know what type of power distribution grounding the drive will be on. Three of the most common grounding methods are: solidly grounded, high-resistance grounded, and ungrounded. Jumpers in our drives allow for installation in any of these configurations. A solidly grounded power distribution is recommended.

Input Fusing and Circuit Breakers

Rockwell Automation offers a full line of Allen-Bradley® circuit breakers and motor protection devices to help meet many of your application needs. The recommended fuse types are listed in the product user manuals.

Line Reactor

Must be applied if:

- Installation site has switched power factor correction capacitors
- Installation site has power interruptions or voltage dips
- The transformer is too large in comparison to the drive See the PowerFlex Common Bus Configuration Selection Guide, publication [DRIVES-SG001](#)

Input Filter

Compact PowerFlex drives: External EMC filter required for EMC compliance. With PowerFlex 523, 525 and 527 AC drives, EMC filtering is embedded at 200V and 400V. Architecture drives: External EMC filter only required with long motor cables and/or specific immunity requirements.

AC Drive

Normal duty (ND) rating: 110% overload for 1 minute and 150% overload for 3 seconds. No excessive starting overload, transient overload, or high duty cycle. Most typical AC drive applications are normal duty.

Heavy duty (HD) rating: 150% overload for 1 minute and 180% overload for 3 seconds. Required for high starting torque (example: heavily loaded conveyors), high brake-away torque (example: extruders and mixers) and high running torque (example: reciprocating compressors).

Output Device or Cable Termination

Required if motor cable lengths exceed stated values. See the PowerFlex Common Bus Configuration Selection Guide, publication [DRIVES-SG001](#)

AC Motor

Inverter-duty rated at a minimum.

PowerFlex AC Drives

The PowerFlex® family of low voltage drives provides the power and control you need and offer a range of power ratings and capabilities to meet your application needs. See the [PowerFlex Compact-class AC Drives Product Overview on page 13](#) and [PowerFlex Architecture-class AC Drives Product Overview on page 14](#) for more information.

PowerFlex AC Drives Performance and Power

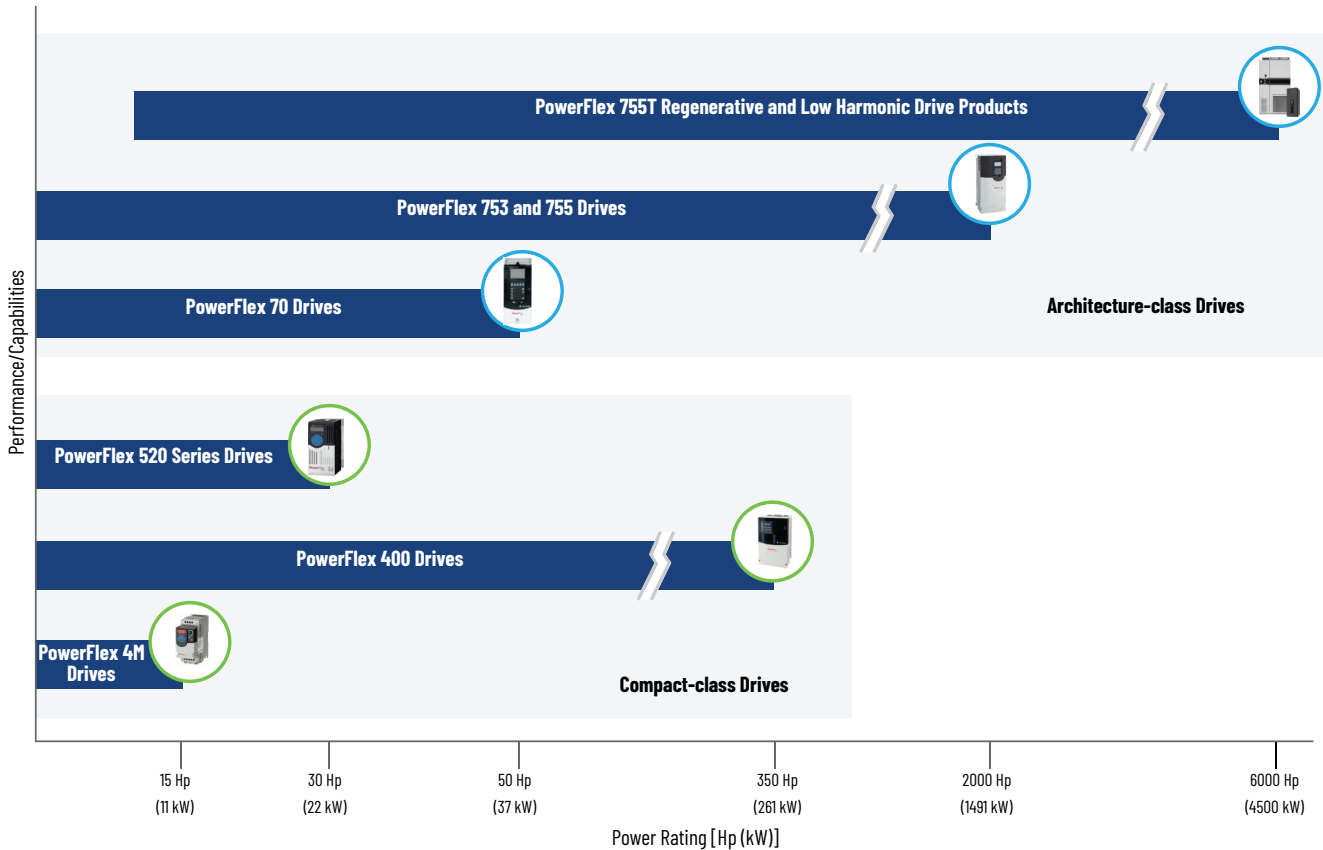

PowerFlex DC Drives

PowerFlex DC drives are available with 1.2...1044 kW/1.5...1400 Hp in voltages from 200...690V. These drives feature regenerative and non-regenerative solutions and various features to accommodate most application needs. See the [PowerFlex DC Drives Product Overview on page 16](#) for more information.

PowerFlex DC Drives Power Rating

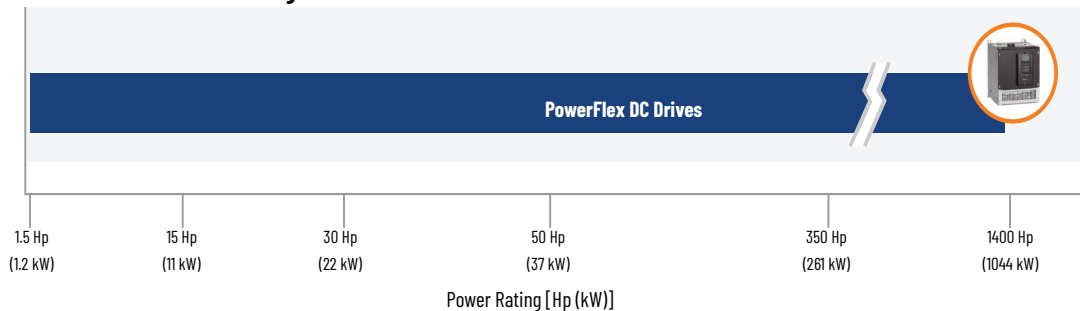

PowerFlex Compact-class AC Drives

PowerFlex Compact-class AC Drives deliver a simple and cost-effective solution for standalone machine level control applications or simple system integration. Designed for ease of use, this general-purpose class of drives provides a compact package to optimize panel space and application versatility.



PowerFlex 4M is the most cost-effective of the PowerFlex family of drives and features feed-through wiring and Zero-Stacking (TM) for ambient temperatures



PowerFlex 400 is ideal for pump and fan applications. Built-in features such as purge and damper input provide a cost-effective solution for speed control in a broad range of variable torque fan and pump applications.

PowerFlex 520-series combines powerful performance with flexible control and focuses on ease of use. Each of the three drives in this family offers a unique set of features to distinctively match the needs of your application.



PowerFlex 523 AC drives are ideal for machines that require cost-effective motor control.

PowerFlex 525 AC drives are ideal for machines with simple system integration and offer standard features including hard-wired Safe Torque Off and a built-in port for EtherNet/IP.

PowerFlex 527 AC drives are used with an Allen-Bradley® Logix programmable controller. They feature:

- Safe Torque Off, either hardwired or deployed over the EtherNet/IP network
- Built-in dual-port EtherNet/IP supports multiple network topologies and Device Level Ring functionality

PowerFlex Architecture-class AC Drives

PowerFlex Architecture-class AC drives provide a broad set of features and application-specific parameters, and they are ideal for high-performance applications.

PowerFlex 70 AC drives are compact packages of power, control, and operator interface that is designed to meet demands for space, simplicity, and reliability. Offered in wall or machine mount with speed and torque control with and without encoder feedback

PowerFlex 753 AC drives feature standard built-in I/O plus three options slots for communications, safety, and additional I/O. They are designed to meet your application requirements for speed and torque control up to 270 kW/400 Hp.

PowerFlex 755 AC drives include multiple control, hardware, and safety options. Built-in EtherNet/IP delivers real time operating data and easily integrates into the Logix control system. Ideal for applications requiring position, speed, or torque control up to 1500 kW/2000 Hp.



PowerFlex 755T Drive Products provide harmonic mitigation, regeneration, and common bus solutions that help you reduce energy costs, gain flexibility and increase productivity. These are the first drives to offer TotalFORCE® technology to achieve excellent motor control through precise, adaptive control of torque, velocity, and position for electric motors. TotalFORCE technology incorporates several patented features that are designed to help optimize your system and maintain productivity.

PowerFlex 755TL Drive – Provides harmonic mitigation and power factor correction by using regenerative power supply technology. By reducing the adverse effects of harmonic distortion, the drive helps to improve energy efficiency, reduce energy costs and minimize power distribution issues on the factory floor.

PowerFlex 755TR Drive – Features built-in regeneration capability that helps decrease energy consumption by delivering regenerative energy from motors back to the incoming supply. Line regeneration reduces the need for braking resistors and associated cooling equipment and helps avoid wasteful dissipation of energy. The drive also offers harmonic mitigation.

PowerFlex 755TM Drive System – Select from a series of predesigned configurations for regenerative common bus supplies and common bus inverters to optimize your system design and power consumption. A common bus drive system offers advantages such as design flexibility, energy optimization and reduced installation costs. PowerFlex 755TM systems provide harmonic mitigation and built-in regeneration capability.



Select a PowerFlex AC Drive Family

Use the following flowchart to help you find the right family of PowerFlex AC drives for your application needs.

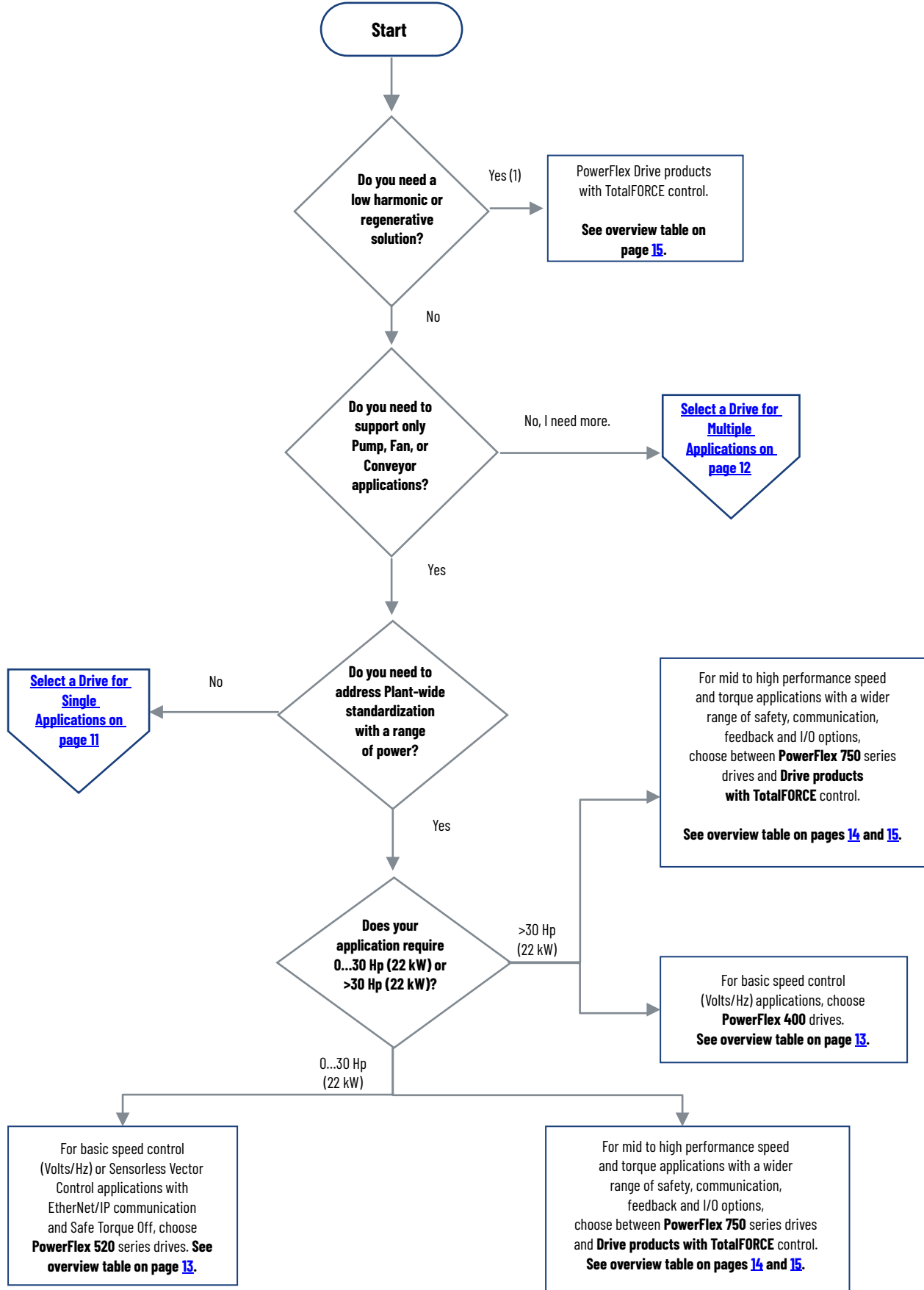

(1) Consider an Engineered to Order solution if the drives in these families do not meet your needs

Select a Drive for Single Applications

Use the following flowchart to help you find the right family of PowerFlex AC drives for your application needs.

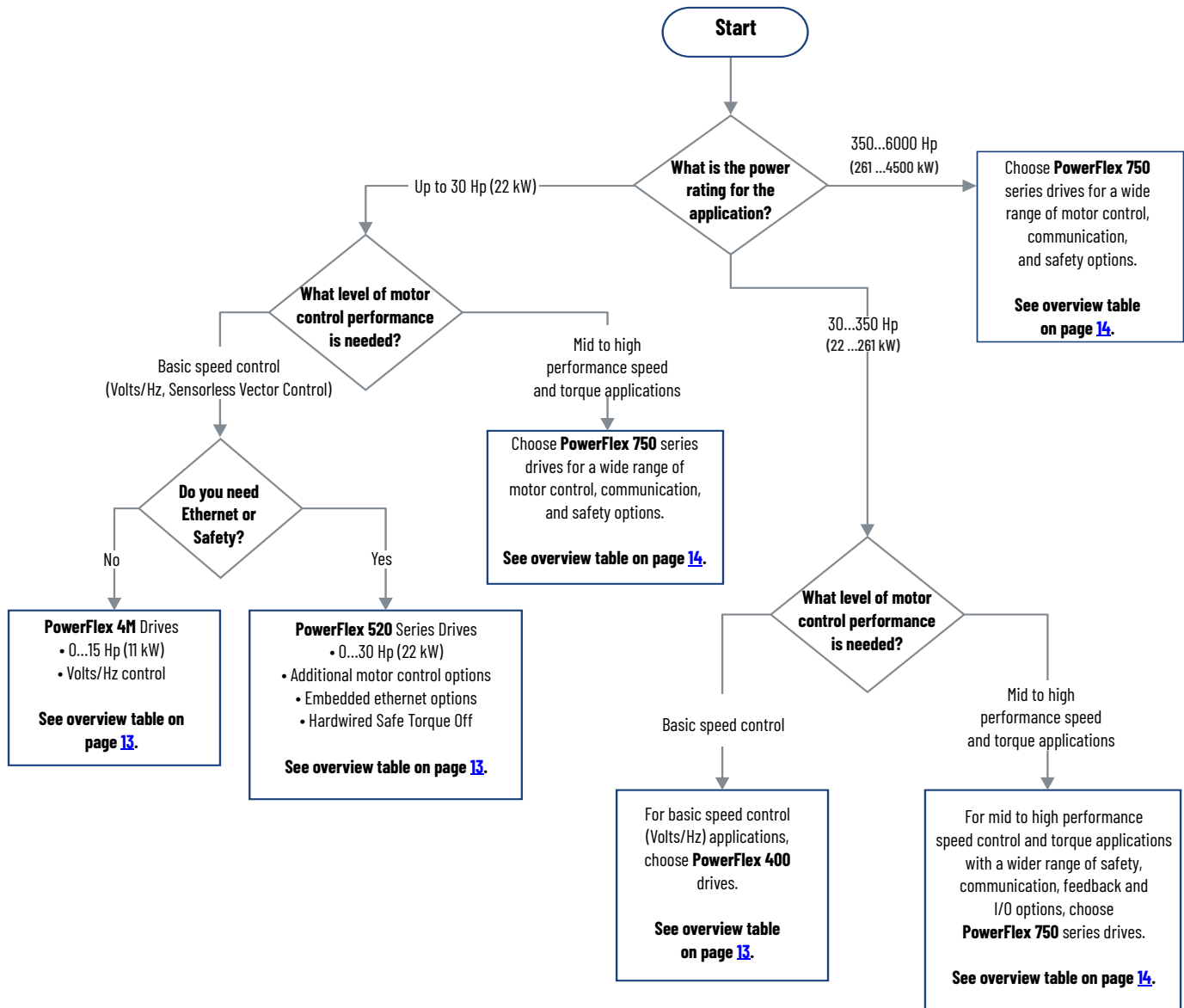

Select a Drive for Multiple Applications

PowerFlex 750-Series Drives and Drive Products with TotalFORCE control support multiple applications, including:

- Pump/Fan
- Conveyors
- Compressors
- Reciprocating Pumps/Compressors
- Mixers/Agitators
- Extruders
- Crane/Hoist/Lift
- Flying Shear/Cutter/Knife
- Centrifuge
- Tensioners
- (Un)Winders/Coilers
- Chippers
- Pump Jack
- Crushers/Shredders
- Press
- Palletizers



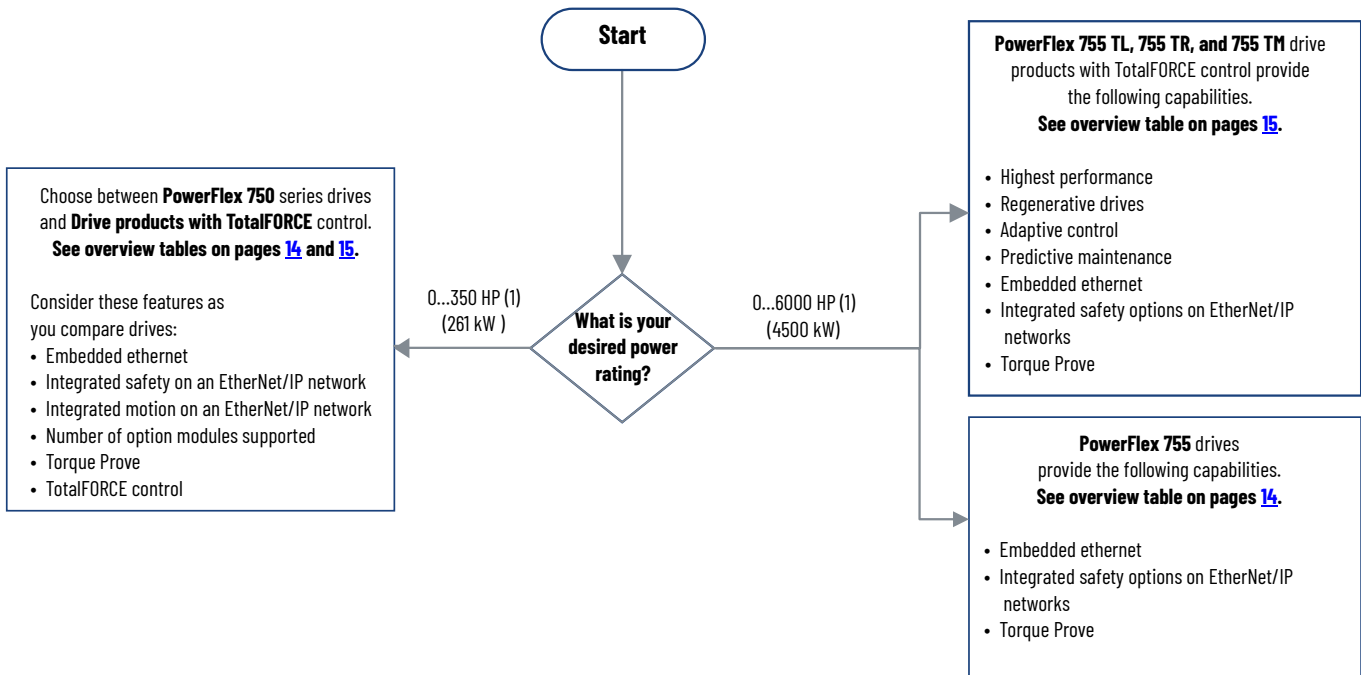

For Common Bus applications, see publication [DRIVES-SG001](#).

Use the following flowchart to help you find the right family of PowerFlex AC drives for your application needs.



(1) Flex 755T Drive products with TotalFORCE control are available for power ratings of 10 Hp and up.

PowerFlex Compact-class AC Drives Product Overview

					
	PowerFlex 4M AC Drive	PowerFlex 400 AC Drive	PowerFlex 523 AC Drive	PowerFlex 525 AC Drive	PowerFlex 527 AC Drive
Selection Guide Page	See page 17	See page 20	See page 24	See page 27	See page 30
Motor Control	<ul style="list-style-type: none"> Volts per Hertz 	<ul style="list-style-type: none"> Volts per Hertz 	<ul style="list-style-type: none"> Volts per Hertz Sensorless vector control 	<ul style="list-style-type: none"> Volts per Hertz Sensorless vector control Closed loop velocity vector control Permanent magnet motor control 	<ul style="list-style-type: none"> Volts per Hertz Sensorless vector control Closed loop velocity vector control
Application	<ul style="list-style-type: none"> Open loop speed regulation 	<ul style="list-style-type: none"> Open loop speed regulation 	<ul style="list-style-type: none"> Open loop speed regulation 	<ul style="list-style-type: none"> Open loop speed regulation Closed loop speed regulation 	<ul style="list-style-type: none"> Open loop speed regulation Closed loop speed regulation
Ratings 100...115V	0.2...1.1 kW 0.25...1.5 Hp 1.6...6 A	—	0.2...1.1 kW 0.25...1.5 Hp 1.6...6 A	0.4...1.1 kW 0.5...1.5 Hp 2.5...6 A	0.4...1.1 kW 0.5...1.5 Hp 2.5...6 A
Ratings 200...240V	0.2...7.5 kW 0.25...10 Hp 1.6...33 A	2.2...37 kW 3.0...50 Hp 12...145 A	0.2...15 kW 0.25...20 Hp 1.6...62.1 A	0.4...15 kW 0.5...20 Hp 2.5...62.1 A	0.4...15 kW 0.5...20 Hp 2.5...62.1 A
Ratings 400...480V	0.4...11 kW 0.5...15 Hp 1.5... 24 A	2.2...37 kW 3.0...50 Hp 12...145 A	0.4...22 kW 0.5...30 Hp 1.4...43 A	0.4...22 kW 0.5...30 Hp 1.4...43 A	0.4...22 kW 0.5...30 Hp 1.4...43 A
Ratings 500...600V	—	—	0.4...22 kW 0.5...30 Hp 0.9...32 A	0.4...22 kW 0.5...30 Hp 0.9...32 A	0.4...22 kW 0.5...30 Hp 0.9...32 A
Communication Options	<ul style="list-style-type: none"> Integral RS-485 (Modbus RTU) Optional⁽¹⁾: EtherNet/IP, ControlNet, DeviceNet, PROFIBUS DP 	<ul style="list-style-type: none"> Integral RS-485 (Modbus RTU, Metasys N2, P1-FLN) Optional⁽¹⁾: EtherNet/IP, ControlNet, DeviceNet, BACnet, LonWorks®, PROFIBUS DP 	<ul style="list-style-type: none"> Integral RS-485 (Modbus RTU) Optional⁽¹⁾ dual-port EtherNet/IP, DeviceNet, PROFIBUS DP 	<ul style="list-style-type: none"> Built-in EtherNet/IP port Integral RS-485 (Modbus RTU) Optional⁽¹⁾: Dual-port EtherNet/IP, DeviceNet, PROFIBUS DP 	<ul style="list-style-type: none"> Built-in dual EtherNet/IP ports
Safety	—	—	—	<ul style="list-style-type: none"> Built-in hardwired Safe Torque Off, SIL 2, PLd, CAT 3 	<ul style="list-style-type: none"> Built-in hardwired Safe Torque Off, SIL 3, PLe, CAT 3 Built-in networked Safe Torque Off, SIL 3, PLe, CAT 3
Certifications and Standards Compliance⁽²⁾	<ul style="list-style-type: none"> c-UL-us CE EAC KCC RCM RoHS 	<ul style="list-style-type: none"> c-UL-us CE EAC KCC RCM RoHS 	<ul style="list-style-type: none"> c-UL-us CE EAC KCC RCM RoHS 	<ul style="list-style-type: none"> c-UL-us CE EAC KCC RCM RoHS 	<ul style="list-style-type: none"> c-UL-us CE EAC KCC RCM RoHS
Features	<ul style="list-style-type: none"> Compact, space saving design Cost-effective Feed-through wiring Drive overload protection and ramp regulation 	<ul style="list-style-type: none"> Ideal for pump and fan applications Designed to meet demands for flexibility, space savings and ease-of-use Drive overload protection, flying start, purge and damper input, hand/off/ auto, and sleep/wake, PID features 	<ul style="list-style-type: none"> Modular design eases installation Economizer motor control for energy savings Application-specific parameter groups Configurable analog output communicates a reference point to another drive or external device Automatic Device Configuration⁽³⁾ 	<ul style="list-style-type: none"> Modular design eases installation Economizer motor control for energy savings Application-specific parameter groups Simple positioning control with optional encoder card Automatic Device Configuration 	<ul style="list-style-type: none"> Modular design eases installation Works exclusively with Logix controllers Choice of hardwired or networked safety Removable terminal blocks help simplify installation Simple positioning control with optional encoder card Automatic Device Configuration
Operating Temperature Information	<ul style="list-style-type: none"> Ambient temperatures up to 50 °C (122 °F) permitted with minimal spacing between drives Zero-Stacking™ Drives for ambient temperatures up to 40 °C (104 °F) 	<ul style="list-style-type: none"> Ambient Temperature up to 50 °C (122 °F) 	<ul style="list-style-type: none"> -20...+50 °C (-4...+122 °F) Up to 70 °C (158 °F) with current derating and optional control module fan kit 	<ul style="list-style-type: none"> -20...+50 °C (-4...+122 °F) Up to 70 °C (158 °F) with current derating and optional control module fan kit 	<ul style="list-style-type: none"> -20...+50 °C (-4...+122 °F) Up to 70 °C (158 °F) with current derating and optional control module fan kit
Configuration and Programming	<ul style="list-style-type: none"> HIM Studio 5000 Logix Designer® Connected Components Workbench software 	<ul style="list-style-type: none"> HIM Studio 5000 Logix Designer Connected Components Workbench software 	<ul style="list-style-type: none"> Multilanguage HIM Studio 5000 Logix Designer Connected Components Workbench software 	<ul style="list-style-type: none"> Multilanguage HIM Studio 5000 Logix Designer Connected Components Workbench software 	<ul style="list-style-type: none"> Motion instructions in Studio 5000 Logix Designer
Technical Data⁽⁴⁾	22F-TD001	22C-TD001	520-TD001	520-TD001	520-TD002



(1) Optional network for use only with DSI External Communications Kit.

(2) For a complete list of Certifications and Standards Compliance, search PowerFlex Certifications on literature.rockwellautomation.com.

(3) Requires dual-port EtherNet/IP Option Module (Cat. No. 25-COMM-E2P)

(4) Technical Data publications contain full product selection, accessories, and specifications information.



PowerFlex Architecture-class AC Drives Product Overview

			
	PowerFlex 70 AC Drive	PowerFlex 753 AC Drive	PowerFlex 755 AC Drive
Selection Guide Page	See page 33	See page 37	See page 42
Motor Control	<ul style="list-style-type: none"> Flux vector control with and without an encoder Sensorless vector control Volts per Hertz 	<ul style="list-style-type: none"> Flux vector control with and without an encoder Sensorless vector control Volts per Hertz Permanent magnet motor control 	<ul style="list-style-type: none"> Flux vector control with and without an encoder Sensorless vector control Volts per Hertz Permanent magnet motor control
Application	<ul style="list-style-type: none"> Open loop speed regulation Closed loop speed regulation Accurate torque and speed regulation 	<ul style="list-style-type: none"> Open loop speed regulation Closed loop speed regulation Accurate torque and speed regulation Indexer positioning 	<ul style="list-style-type: none"> Open loop speed regulation Closed loop speed regulation Accurate torque and speed regulation Accurate positioning with PCAM, indexer, and gearing
Single-phase Input with Derate	Yes	Yes	Yes (frames 1...7); No (Frames 8...10)
Ratings 200...240V	0.37...18.5 kW 0.5...25 Hp 2.2...70 A	0.37...132 kW 0.5...200 Hp 2.2...477 A	0.37...132 kW 0.5...200 Hp 2.2...477 A
Ratings 400...480V	0.37...37 kW 0.5...50 Hp 1.1...72 A	0.75...270 kW 1...400 Hp 2.1...477 A	0.75...1400 kW 1...2000 Hp 2.1...2330 A
Ratings 500...600V	0.37...37 kW 0.5...50 Hp 0.9...52 A	1...300 Hp 1.7... 289 A	1...1500 Hp 1.7...1530 A
Ratings 690V	—	7.5...250 kW 12...263 A	0.75...1500 kW 12...1485 A
Communication Options	<ul style="list-style-type: none"> Internal DPI™ Options: Single or dual-port EtherNet/IP, ControlNet (Coax or Fiber), DeviceNet, BACnet, CANopen, ExternalSCANport, Interbus, LonWorks, Modbus/TCP, PROFIBUS DP, RS-485 DFI, RS-485 HVAC (Modbus RTU, Metasys N2, Siemens P1) 	<ul style="list-style-type: none"> Options: Single or dual-port Ethernet/IP, ControlNet (Coax or Fiber), DeviceNet, BACnet/IP, CANopen, HVAC (Modbus RTU, FLN P1, Metasys N2), Modbus/TCP, LonWorks, PROFIBUS DP, PROFINET IO, RS-485 DFI 	<ul style="list-style-type: none"> Internal DPI Built-in EtherNet/IP port or dual-port EtherNet/IP option Options: ControlNet (Coax or Fiber), DeviceNet, BACnet, CANopen, External SCANport™, HVAC (Modbus RTU, FLN P1, Metasys N2), LonWorks, Modbus/TCP RS-485 DFI, RS-485 DFI, PROFINET IO
Safety	<ul style="list-style-type: none"> Hardwired Safe Torque Off SIL 2, PLd, CAT 3 - option 	<ul style="list-style-type: none"> Hardwired Safe Torque Off SIL 3, PLe, CAT 3 - option Hardwired Safe Speed Monitor SIL 3, PLe, CAT 4 - option 	<ul style="list-style-type: none"> Hardwired Safe Torque Off SIL 3, PLe, CAT 3 - option Networked Safe Torque Off SIL 3, PLe, CAT 3 - option Hardwired Safe Speed Monitor SIL 3, PLe, CAT 4 - option Networked Integrated Safety Functions SIL CL 3 and PLe Cat 4 - option
Certifications and Standards Compliance⁽¹⁾	<ul style="list-style-type: none"> c-UL-us CE EAC KCC RCM RoHS 	<ul style="list-style-type: none"> c-UL-us CE EAC KCC RCM RoHS 	<ul style="list-style-type: none"> c-UL-us CE EAC KCC RCM RoHS
Features	<ul style="list-style-type: none"> Embedded I/O standard Speed and torque control with and without encoder feedback P-Jump and Traverse for Fibers applications Flexible packaging and mounting 	<ul style="list-style-type: none"> Embedded I/O standard Predictive diagnostics Adjustable voltage control Three option slots for I/O, feedback, safety, auxiliary control power, communications Application-specific control for indexing, oil well and fiber applications 	<ul style="list-style-type: none"> Predictive diagnostics Five option slots for I/O, feedback, safety, auxiliary control power, communications TorqProve™ for lifting applications Application-specific control for indexing, oil well, and fiber applications Adjustable voltage control Convenient roll-in/out design for floor mount drives
Configuration and Programming	<ul style="list-style-type: none"> HIM Studio 5000 Logix Designer Connected Components Workbench software 	<ul style="list-style-type: none"> HIM Studio 5000 Logix Designer Connected Components Workbench software 	<ul style="list-style-type: none"> HIM Studio 5000 Logix Designer Connected Components Workbench software
Technical Data⁽²⁾	20A-TD001	750-TD001	750-TD001

(1) For a complete list of Certifications and Standards Compliance, search PowerFlex Certifications on literature.rockwellautomation.com.

(2) Technical Data publications contain full product selection, accessories, and specifications information.

PowerFlex 755T AC Drives with TotalFORCE Technology Product Overview

			
	PowerFlex 755TL AC Drive	PowerFlex 755TR AC Drive	PowerFlex 755TM AC Drive
Selection Guide Page	See page 47	See page 47	See page 47
Motor Control	<ul style="list-style-type: none"> • Sensorless vector • Flux vector control • Volts per Hertz • Economizer • Field-oriented control • Permanent magnet motor control 	<ul style="list-style-type: none"> • Sensorless vector • Flux vector control • Volts per Hertz • Economizer • Field-oriented control • Permanent magnet motor control 	<ul style="list-style-type: none"> • Sensorless vector • Flux vector control • Volts per Hertz • Economizer • Field-oriented control • Permanent magnet motor control
Application	<ul style="list-style-type: none"> • Open loop speed regulation • Closed loop speed regulation • Precise torque, position, and speed regulation • Accurate positioning with PCAM, indexer, and gearing 	<ul style="list-style-type: none"> • Open loop speed regulation • Closed loop speed regulation • Accurate torque and speed regulation • Accurate positioning with PCAM, indexer, and gearing 	<ul style="list-style-type: none"> • Open loop speed regulation • Closed loop speed regulation • Precise torque and speed regulation • Accurate positioning with PCAM, indexer, and gearing
Single-phase Input with Derate Ratings 200...240V	No	No	—
Ratings 400...480V	7.5...1400 kW 10...1800 Hp 14...2156 A	7.5...4500 kW 10... 6000 Hp 14...6734 A	Common Bus Inverter: • 160...3640 kW • 302...7007 A @400V • 250...6000 Hp • 302...6734 A @480V Regenerative Bus Supplies: • 87...4358 kW • 150...7517 A @400V • 90...4818 kW • 129...6925 A @480V
Ratings 500...600V	10...1500 Hp 11...1430 A	10... 5100 Hp 11...4960 A	Common Bus Inverter: • 250... 5100 Hp • 242...4960 A @ 600V Regenerative Bus Supplies: • 69...4432 kW • 79...5096 A @ 600V
Ratings 690V	11...1400 kW 15...1419 A	11...4550 kW 15...4596 A	Common Bus Inverter: • 200...4550 kW • 215...4596 A Regenerative Bus Supplies: • 84...4714 kW • 84...4714 A
Communication Options	<ul style="list-style-type: none"> • Internal DPI • Built-in dual EtherNet/IP ports • Options: ControlNet, DeviceNet, PROFIBUS DP, PROFINET 	<ul style="list-style-type: none"> • Internal DPI • Built-in dual EtherNet/IP ports • Options: ControlNet, DeviceNet, PROFIBUS DP, PROFINET 	<ul style="list-style-type: none"> • Internal DPI • Built-in dual EtherNet/IP ports • Options: ControlNet, DeviceNet, PROFIBUS DP, PROFINET
Safety Options	<ul style="list-style-type: none"> • Hardwired Safe Torque Off SIL 3, PLe, CAT 3 • Networked Safe Torque Off SIL 3, PLe, CAT 3 • Hardwired Safe Speed Monitor SIL 3, PLe, CAT 4 • Networked Integrated Safety Functions SIL CL 3 and PLe Cat 4 	<ul style="list-style-type: none"> • Hardwired Safe Torque Off SIL 3, PLe, CAT 3 • Networked Safe Torque Off SIL 3, PLe, CAT 3 • Hardwired Safe Speed Monitor SIL 3, PLe, CAT 4 • Networked Integrated Safety Functions SIL CL 3 and PLe Cat 4 	<ul style="list-style-type: none"> • Hardwired Safe Torque Off SIL 3, PLe, CAT 3 • Networked Safe Torque Off SIL 3, PLe, CAT 3 • Hardwired Safe Speed Monitor SIL 3, PLe, CAT 4 • Networked Integrated Safety Functions SIL CL 3 and PLe Cat 4
Certifications and Standards Compliance⁽¹⁾	<ul style="list-style-type: none"> • c-UL-us • CE • EAC • KCC • RCM • RoHS 	<ul style="list-style-type: none"> • c-UL-us • CE • EAC • KCC • RCM • RoHS 	<ul style="list-style-type: none"> • c-UL-us • CE • EAC • KCC • RCM • RoHS
Features	<ul style="list-style-type: none"> • Provides harmonic mitigation and power factor correction • TotalFORCE technology with patented features to help optimize your system and maintain productivity • Predictive diagnostics and maintenance • Efficient installation and maintenance with convenient roll in/out design • High power density with compact footprint • TorqProve™ for lifting applications • Five option slots for I/O, feedback, safety, auxiliary control power, communications 	<ul style="list-style-type: none"> • Provides harmonic mitigation and power factor correction • TotalFORCE technology with patented features to help optimize your system and maintain productivity • Predictive diagnostics and maintenance • Efficient installation and maintenance with convenient roll in/out design • High power density with compact footprint • TorqProve for lifting applications • Five option slots for I/O, feedback, safety, auxiliary control power, communications 	<ul style="list-style-type: none"> • Common bus drive system helps provide design flexibility, minimize floor space, and reduce installation costs • Provides harmonic mitigation, power factor correction and regenerative capability • TotalFORCE technology with patented features helps optimize your system and maintain productivity • Predictive diagnostics and maintenance • Designed to enable coordination of multiple motors • High power density with compact footprint • TorqProve for lifting applications • Five option slots for I/O, feedback, safety, communications
Configuration and Programming	<ul style="list-style-type: none"> • HIM • Studio 5000 Logix Designer • Connected Components Workbench software 	<ul style="list-style-type: none"> • HIM • Studio 5000 Logix Designer • Connected Components Workbench software 	—
Technical Data⁽²⁾	750-TD100	750-TD100	750-TD100

(1) For a complete list of Certifications and Standards Compliance, search PowerFlex Certifications on literature.rockwellautomation.com.

(2) Technical Data publications contain full product selection, accessories, and specifications information.

PowerFlex DC Drives Product Overview



	PowerFlex DC Drive
Selection Guide Page	See page 55
Motor Control	<ul style="list-style-type: none"> • Regenerative and Non-regenerative • Field Weakening and Economize
Ratings 200...240V	1.2...224 kW 1.5...300 Hp 7...1050 A
Ratings 400...480V	1.5...671 kW 2...900 Hp 4.1...1494 A
Ratings 500...600V	37...932 kW 50...1250 Hp 67.5...1688 A
Ratings 690V	298...1044 kW 400...1400 Hp 452...1582 A
Certifications and Standards Compliance⁽¹⁾	<ul style="list-style-type: none"> • c-UL-us • CE • EAC • KCC • RCM • RoHS
Features	<ul style="list-style-type: none"> • Overload Protection • PID Control (Speed or Torque) • Embedded I/O standard • Integrated field supply • Adaptive Gain, Droop, Feedback Loss Switchover • TorqProve™ for lifting applications
Technical Data⁽²⁾	20P-TD001

(1) For a complete list of Certifications and Standards Compliance, search PowerFlex Certifications on literature.rockwellautomation.com.
 (2) Technical Data publications contain full product selection, accessories, and specifications information.

PowerFlex 4M AC Drives

0.2...11 kW/0.25...15 Hp in voltages from 100...480V

Providing users with motor speed control in a compact, space-saving design, the PowerFlex® 4M AC drive is the smallest and most cost-effective member of the PowerFlex family of drives.

Providing application flexibility, feed-through wiring and ease-of-programming, this drive is ideal for machine-level speed control for applications that require space-saving and easy-to-use AC drives.

Attribute	Value
Ratings	
100...120V	0.2...1 kW/0.25...1.5 Hp/1.6...6 A
200...240V	0.2...7.5 kW/0.25...10 Hp/1.6...33 A
380...480V	0.2...11 kW/0.25...15 Hp/1.6...24 A
Motor Control	VHz Control
Enclosures	IP20, NEMA/UL Type Open



1. Feed-through wiring design for simple retrofitting into applications that require variable speed motor control.
2. Integral keypad included. NEMA/UL Type 4X remote and Type 1 handheld keypads are available.
3. Communications: Integral RS-485.
4. Embedded I/O: 5 digital inputs, 1 relay output, 1 analog input, and 1 PTC input.
5. Internal brake IGBT in Frame C drives.

For accessories and options, including HIMs, communication, and power conditioning options, see PowerFlex 4 and 40 AC Drive Specifications Technical Data, [22F-TD001](#).



Catalog Number Explanation

Catalog number positions 1..7 identify the product type and voltage rating.

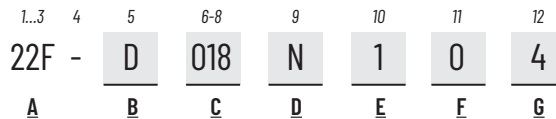

A	
Drive	
Code	Type
22F	PowerFlex 4M

B		
Voltage Rating		
Code	Voltage	Phase
V	120V AC	1
A	240V AC	1
B	240V AC	3
D	480V AC	3

C1		
Rating		
100...120V AC, Single-phase Input		
Code	Description	kW (Hp)
1P6	1.6	0.2 (0.25)
2P5	2.5	0.4 (0.5)
4P5	4.5	0.75 (1.0)
6P0	6.0	1.1 (1.5)

C2		
Rating		
200...240V AC, Single-phase Input		
Code	Amps	kW (Hp)
1P6	1.6	0.2 (0.25)
2P5	2.5	0.4 (0.5)
4P2	4.2	0.75 (1.0)
8P0	8.0	1.5 (2.0)
011	11	2.2 (3.0)

C3		
Rating		
200...240V AC, Three-phase Input		
Code	Amps	kW (Hp)
1P6	1.6	0.2 (0.25)
2P5	2.5	0.4 (0.5)
4P2	4.2	0.75 (1.0)
8P0	8.0	1.5 (2.0)
012	12	2.2 (3.0)
017	17.5	3.7 (5.0)
025	25.0	5.5 (7.5)
033	33.0	7.5 (10.0)

C4		
Rating		
380...480V AC, Three-phase Input		
Code	Amps	kW (Hp)
1P5	1.5	0.4 (0.5)
2P5	2.5	0.75 (1.0)
4P2	4.2	1.5 (2.0)
6P0	6.0	2.2 (3.0)
8P7	8.7	3.7 (5.0)
013	13.0	5.5 (7.5)
018	18.0	7.5 (10.0)
024	24.0	10.0 (15.0)

D	
Enclosure	
Code	Enclosure
N	Panel Mount - IP20 (NEMA/UL Type Open)

E	
HIM	
Code	Interface Module
1	Fixed Keypad

F	
Emission Class	
Code	EMC Filter
0	No Filter
1	Filter

G	
Brake	
Code	Description
3	No Brake IGBT
4	Standard

Approximate Dimensions and Weights

Dimensions are in mm (in.) - weights are in kg (lb)

IP20, NEMA/UL Type Open

Frame	H	W	D	Weight
A	174 (6.85)	72 (2.83)	136 (5.35)	1.58 (3.5)
B		100 (3.94)		2.09 (4.6)
C	260 (10.24)	130 (5.12)	180 (7.09)	4.81 (10.6)

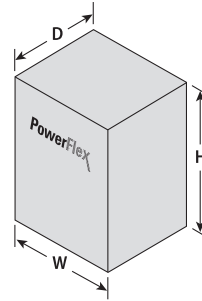

PowerFlex 400 AC Drives

2.2...250 kW/3...350 Hp in voltages from 200...480V

Providing users with easy installation and ideal for mechanical fan and pump systems, the PowerFlex 400 AC drive offers a wide range of built-in features that allow for seamless building system integration. The PowerFlex 400 is designed to meet global OEM, contractor, and end-user demands for flexibility, space savings, and ease-of-use.

Attribute	Value
Ratings	
200...240V	2.2...37 kW/3...50 Hp/12...145 A
380...480V	2.2...250 kW/3...350 Hp/6...460 A
Motor Control	VHz Control
Enclosures	<ul style="list-style-type: none"> • IP20, NEMA/UL Type Open • Flange Mount • Front = IP20, NEMA/UL Type Open, Back/Heatsink = IP40/54/65, NEMA/UL Type 1/12/4/4X • IP30, NEMA/UL Type 1 (with optional kit)
Additional Features	PID/ PIP for fan and pump applications

1. Integral keypad included. NEMA/UL Type 4X remote and Type 1 handheld keypads are available.
2. Communications: Integral RS-485.
3. Embedded I/O: 7 digital inputs, 2 relay outputs, 2 analog inputs, 1 transistor, 2 analog outputs, and 1 PTC input. Extension option available.

For accessories and options, including HIMs, communication, and power conditioning options, see PowerFlex 400 AC Drive Specifications Technical Data, [22C-TD001](#).

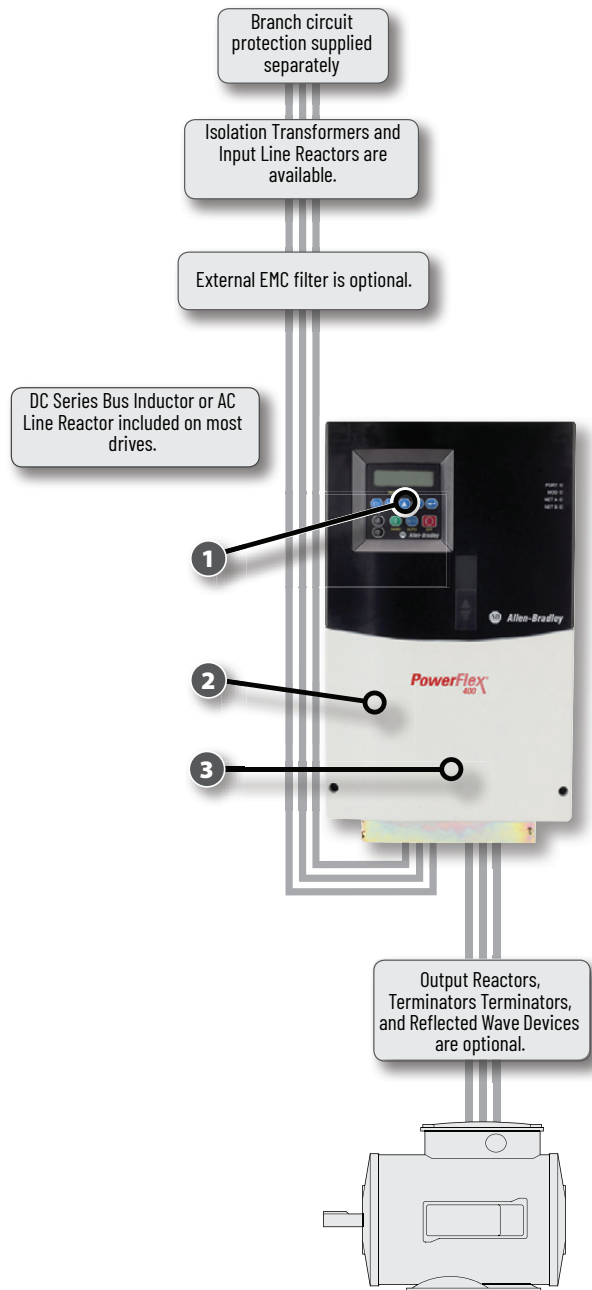

Catalog Number Explanation

Catalog number positions 1...7 identify the product type and voltage rating.

1...3 4 5 6-8 9 10 11 12
 22C - D 038 A 1 0 3
 A B C D E F G

A Drive	
Code	Type
22C	PowerFlex 400

B Voltage Rating		
Code	Voltage	Phase
B	240V AC	3
D	480V AC	3

C1 Rating			
200...240V Input			
Code	Amps	kW(Hp)	Frame
012	12	2.2 (3.0)	C
017	17.5	3.7 (5.0)	C
024	24	5.5 (7.5)	C
033	33	7.5 (10.0)	C
049	49	11 (15)	D
065	65	15 (20)	D
075	75	18.5 (25)	D
090	90	22 (30)	D
120	120	30 (40)	E
145	145	37 (50)	E

C2 Rating			
380...480V Input			
Code	Amps	kW(Hp)	Frame
6P0	6	2.2 (3.0)	C
010	10.5	4.0 (5.0)	C
012	12	5.5 (7.5)	C
017	17	7.5 (10.0)	C
022	22	11 (15)	D
030	30	15 (20)	D
038	38	18.5 (25)	D
045	45.5	22 (30)	D
060	60	30 (40)	E
072	72	37 (50)	E
088	88	45 (60)	E
105	105	55 (75)	E
142	142	75 (100)	E
170	170	90 (125)	F
208	208	110 (150)	F
260	260	132 (200)	G
310	310	160 (250)	G
370	370	200 (300)	H
460	460	250 (350)	H

D Enclosure	
Code	Enclosure
N	Panel Mount - IP20 NEMA/UL Type Open ⁽¹⁾
A	Panel Mount - IP30 NEMA/UL Type 1 ⁽²⁾
F	Flange Mount - IP20 NEMA/UL Type Open ⁽³⁾

- (1) Frame C drives only available with IP20, NEMA/UL Type Open enclosure. Field installed conversion kit available to achieve IP30, NEMA/UL Type 1 rating.
 (2) Frame D, E, and F drives only available with IP30, NEMA/UL Type 1 enclosure.
 (3) Frame C drives only.

E HIM	
Code	Interface Module
1	Fixed Keypad

F Emission Class	
Code	EMC Filter
0	No Filter

G Version	
Code	Description
3	No Brake IGBT

Approximate Dimensions and Weights

Dimensions are in mm (in.) - weights are in kg (lb)

Panel Mount

Frame	H	W	D	Weight ⁽¹⁾
C	260 (10.2) 320 (12.6) ⁽²⁾	130 (5.1)	180 (7.1)	7.49 (16.5)
D	436.2 (17.17)	250 (9.84)	206.1 (8.11)	15.6 (34.4)
E	605.5 (23.84)	370 (14.57)	259.2 (10.21)	51.2 (112.9)
F	850 (33.46)	425 (16.73)	280 (11.02)	88 (194)
G	892 (35.12)	425 (16.73)	264 (10.39)	106 (233.7)
H	1363.8 (53.69)	529.2 (20.83)	358.6 (14.12)	177 (390.2)

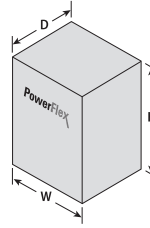

(1) Weights are approximate. See the PowerFlex 400 User Manual, publication [22C-UM001](#), for detailed weight information.

(2) Drive with IP30, NEMA 1/ULType 1 option kit installed.

Flange Mount

Frame	H	W	D1	D2	Weight ⁽¹⁾
C	325 (12.8)	300 (11.81)	105.8 (4.17)	138.2 (5.44)	3.85 (8.5)

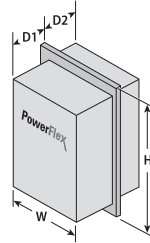

(1) Weights are approximate. See the PowerFlex 400 User Manual, publication [22C-UM001](#), for detailed weight information.

PowerFlex 4 AC Drives



Designed to meet global OEM and end-user demands for simplicity, space savings, and cost efficiency, this drive provides intuitive features such as an integral keypad with local potentiometer and control keys that are active right out of the box.

Attribute	Value
Ratings	
100...120V	0.2...1.1 kW / 0.25...1.5 Hp / 1.5...6 A
200...240V	0.2...3.7 kW / 0.25...5 Hp / 1.4...17.5 A
380...480V	0.4...3.7 kW / 0.5...5 Hp / 1.4...8.7 A
Motor Control	VHz Control
Enclosures	<ul style="list-style-type: none"> • IP20, NEMA/UL Type Open • Plate Drive: Front = IP20, NEMA/ULType Open • Flange Mount: Front = IP20, NEMA/ULType; Open Back/Heatsink = IP40/54/65; NEMA/ULType 1/12/4/4X • IP30, NEMA/ULType 1(with optional kit)

PowerFlex 40 AC Drives



The PowerFlex 40 AC drive gives OEMs, machine builders, and end users performance-enhancing motor control in an easy to-use, compact package. The PowerFlex 40 features sensorless vector control to meet low speed torque demands that help improve application performance. With flexible packaging options and an uncomplicated programming structure, this drive can be quickly and easily installed and configured for various applications.

Attribute	Value
Ratings	
100...120V	0.4...1.1 kW / 0.5...1.5 Hp / 2.3...6 A
200...240V	0.4...7.5 kW / 0.5...10 Hp / 2.3...33 A
380...480V	0.4...11 kW / 0.5...15 Hp / 1.4...24 A
500...600V	0.75...11 kW / 1...15 Hp / 1.7...19 A
Motor Control	VHz Control
Enclosures	<ul style="list-style-type: none"> • IP20, NEMA/UL Type Open • Plate Drive: Front = IP20, NEMA/ULType Open • Flange Mount: Front = IP20, NEMA/ULType; Open Back/Heatsink = IP40/54/65; NEMA/ULType 1/12/4/4X • IP30, NEMA/ULType 1 (with optional kit) • IP66, NEMA/ULType 4

For accessories and options, including HIMs and communication options, see PowerFlex 4 and 40 AC Drive Specifications Technical Data, [22-TD001](#).

PowerFlex 40P AC Drives



The PowerFlex 40P AC drive addresses user needs for closed loop control with an option for Category 3 Safe Torque Off in a compact and cost-effective design. Based on the popular PowerFlex 40, this drive is designed to meet global OEM and end-user demands for flexibility, space savings, and ease of use. This drive is a cost-effective alternative for speed or basic position control of applications such as diverters, smart conveyors, packaging machines, palletizers, drafting machines, ring spinning machines, and synthetic fiber spinning machines and shares common options and accessories with the PowerFlex 40.

Attribute	Value
Ratings	
200...240V	0.4...7.5 kW / 0.5...10 Hp / 2.3...33 A
380...480V	0.4...11 kW / 0.5...15 Hp / 1.4...24 A
500...600V	0.75...11 kW / 1...15 Hp / 1.7...19 A
Motor Control	VHz Control Sensorless Vector Control
Enclosures	<ul style="list-style-type: none"> • IP20, NEMA/UL Type Open • Plate Drive: Front = IP20, NEMA/ULType Open • Flange Mount: Front = IP20, NEMA/ULType; Open Back/Heatsink = IP40/54/65; NEMA/ULType 1/12/4/4X • IP30, NEMA/ULType 1(with optional kit)

For accessories and options, including HIMs and communication options, see PowerFlex 40P AC Drive Specifications Technical Data, [22D-TD001](#).

PowerFlex 523 AC Drives

0.2...22 kW/0.25...30 Hp in voltages from 100...600V

PowerFlex 523 AC drives are designed to help reduce installation and configuration time with an innovative modular design while providing just enough control for your application. These drives offer convenient programming features with the fast upload and download of configuration files over a standard USB connection, and installation flexibility with Zero-Stacking and a high ambient operating temperature. PowerFlex 523 AC drives also provide various motor control options, making these drives ideal for simple applications.

Attribute	Value
Ratings	100...120V / 0.2...1.1 kW / 0.25...1.5 Hp / 1.6...6 A 200...240V / 0.2...1.5 kW / 0.25...2.0 Hp / 1.6...6.21 A 380...480V / 0.4...2.2 kW / 0.5...3.0 Hp / 1.4...4.3 A 525...600V / 0.4...2.2 kW / 0.5...3.0 Hp / 0.9...3.2 A
Motor Control	VHz Control Sensorless Vector Control Sensorless Vector Control with Economizer
Enclosures	<ul style="list-style-type: none"> IP20, NEMA/UL Type Open IP30, NEMA/UL Type 1 (with optional kit)
Communication Options	<ul style="list-style-type: none"> Option for dual-port EtherNet/IP adapter DeviceNet and PROFIBUS DP adapters also available
Additional Features	<ul style="list-style-type: none"> Automatic Device Configuration Economizer motor control⁽¹⁾ Conformal coating to IEC 60721 3C2 standards

(1) Requires Dual-port EtherNet/IP Option Module (cat. no. 25-COMM-E2P).

1. LCD QuickView® Human Interface Module (HIM) with multi-language support in scrolling text.
2. Communications: Integral RS-485 with Modbus RTU/DSI. Other communication options available and can be added to the drive without size penalty.
3. Embedded I/O: 5 digital inputs, 1 analog input, 1 analog output (requires firmware revision 3 and Series B hardware), and 1 relay output.
4. Integral brake IGBT.

For accessories and options, including HIMs and communication options, see PowerFlex 523 and PowerFlex 525 AC Drive Specifications Technical Data, [520-TD001](#).



Catalog Number Explanation

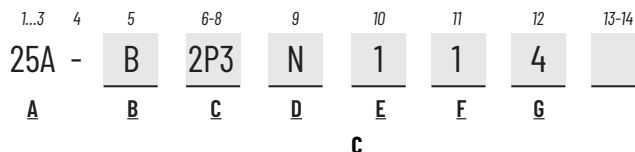

A

Drive	
Code	Type
25A	PowerFlex 523
25B	PowerFlex 525

B

Voltage Rating		
Code	Voltage	Phase
V	120V AC	1
A	240V AC	1
B	240V AC	3
D	480V AC	3
E	600V AC	3

C

Output Current @ 1 Phase, 100...120V Input						
Code	Amps	ND		HD		Frame
		HP	kW	HP	kW	
1P6	1.6	0.25	0.2	0.25	0.2	A
2P5	2.5	0.5	0.4	0.5	0.4	A
4P8	4.8	1.0	0.75	1.0	0.75	B
6P0	6.0	1.5	1.1	1.5	1.1	B

Output Current @ 1 Phase, 200...240V Input						
Code	Amps	ND		HD		Frame
		HP	kW	HP	kW	
1P6	1.6	0.25	0.2	0.25	0.2	A
2P5	2.5	0.5	0.4	0.5	0.4	A
4P8	4.8	1.0	0.75	1.0	0.75	A
8P0	8.0	2.0	1.5	2.0	1.5	B
011	11.0	3.0	2.2	3.0	2.2	B

Output Current @ 3Phase, 200...240V Input						
Code	Amps	ND		HD		Frame
		HP	kW	HP	kW	
1P6	1.6	0.25	0.2	0.25	0.2	A
2P5	2.5	0.5	0.4	0.5	0.4	A
5P0	5.0	1.0	0.75	1.0	0.75	A
8P0	8.0	2.0	1.5	2.0	1.5	A
011	11.0	3.0	2.2	3.0	2.2	A
017	17.5	5.0	4.0	5.0	4.0	B
024	24.0	7.5	5.5	7.5	5.5	C
032	32.2	10.0	7.5	10.0	7.5	D
048	48.3	15.0	11.0	10.0	7.5	E
062	62.1	20.0	15.0	15.0	11.0	E

Output Current @ 3Phase, 380...480V Input

Code	Amps	ND		HD		Frame
		HP	kW	HP	kW	
1P4	1.4	0.5	0.4	0.5	0.4	A
2P3	2.3	1.0	0.75	1.0	0.75	A
4P0	4.0	2.0	1.5	2.0	1.5	A
6P0	6.0	3.0	2.2	3.0	2.2	A
010	10.5	5.0	4.0	5.0	4.0	B
013	13.0	7.5	5.5	7.5	5.5	C
017	17.0	10.0	7.5	10.0	7.5	C
024	24.0	15.0	11.0	15.0	11.0	D
030	30.0	20.0	15.0	15.0	11.0	D
037	37.0	25.0	18.5	20.0	15.0	E
043	43.0	30.0	22.0	25.0	18.5	E

Output Current @ 3Phase, 525...600V Input

Code	Amps	ND		HD		Frame
		HP	kW	HP	kW	
0P9	0.9	0.5	0.4	0.5	0.4	A
1P7	1.7	1.0	0.75	1.0	0.75	A
3P0	3.0	2.0	1.5	2.0	1.5	A
4P2	4.2	3.0	2.2	3.0	2.2	A
6P6	6.6	5.0	4.0	5.0	4.0	B
9P9	9.9	7.5	5.5	7.5	5.5	C
012	12.0	10.0	7.5	10.0	7.5	C
019	19.0	15.0	11.0	15.0	11.0	D
022	22.0	20.0	15.0	15.0	11.0	D
027	27.0	25.0	18.5	20.0	15.0	E
032	32.0	30.0	22.0	25.0	18.5	E

D

Enclosure	
Code	Enclosure
N	Panel Mount - IP20 NEMA/UL Type Open

E

HIM	
Code	Interface Module
1	Standard

F

Emission Class	
Code	EMC Filter
0	No Filter
1	Filter

G

Braking	
Code	Description
4	Standard

Approximate Dimensions and Weights

Dimensions are in mm (in.) - weights are in kg (lb)

IP20, NEMA/UL Type Open

Frame	H	W	D	Weight
A	152 (5.98)	72 (2.83)	172 (6.77)	1.1 (2.4)
B	180 (7.08)	87 (3.42)	172 (6.77)	1.6 (3.5)
C	220 (8.66)	109 (4.29)	184 (7.24)	2.3 (5.1)
D	260 (10.23)	130 (5.11)	212 (8.34)	3.2 (7.1)
E	300 (11.81)	185 (7.28)	279 (10.98)	12.9 (28.4)

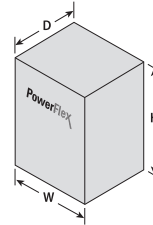

PowerFlex 525 AC Drives

0.4...22 kW/0.5...30 Hp in voltages from 100...600V

PowerFlex 525 AC drives feature an innovative, modular design offering fast and easy installation and configuration. These cost-effective compact drives come with embedded EtherNet/IP™ communications, safety, USB configuration, and a high ambient operating temperature capability.

PowerFlex 525 AC drives also provide various motor control algorithms including volts per Hertz, sensorless vector control, closed loop velocity vector control, and permanent magnet motor control, making these drives ideal for a vast array of applications.

Attribute	Value
Ratings	100...120V 200...240V 380...480V 525...600V
	0.4...1.1 kW / 0.5...1.5 Hp / 2.5...6 A 0.4...15 kW / 0.5...20 Hp / 2.5...62.1 A 0.4...22 kW / 0.5...30 Hp / 1.4...43 A 0.4...22 kW / 0.5...30 Hp / 0.9...32 A
Motor Control	<ul style="list-style-type: none"> • VHz Control • Closed Loop Velocity Vector Control • Sensorless Vector Control • Permanent Magnet Motor Control⁽¹⁾
Enclosures	<ul style="list-style-type: none"> • IP20, NEMA/UL Type Open • IP30, NEMA/UL Type 1 (with optional kit)
Communication Options	<ul style="list-style-type: none"> • Built-in EtherNet/IP port • Option for dual-port EtherNet/IP adapter • DeviceNet and PROFIBUS DP adapters also available
Additional Features	<ul style="list-style-type: none"> • Automatic Device Configuration • Economizer motor control • Conformal coating to IEC 60721 3C2 standards

(1) Requires firmware revision 5 or later; hardware change in not required.

1. LCD QuickView® Human Interface Module (HIM) with multi-language support in scrolling text.
2. Communications: Built-in EtherNet/IP port with option for dual-port EtherNet/IP adapter.
3. Machine safety with built-in Safe Torque Off SIL 2, PLd, CAT 3 (meets ISO 13849-1).
4. Embedded I/O: 7 digital inputs, 2 digital outputs, 2 analog inputs, 1 analog output, and 2 relay outputs.
5. Integral Brake IGBT Transistor.

For accessories and options, including HIMs and communication options, see PowerFlex 523 and PowerFlex 525 AC Drive Specifications Technical Data, [520-TD001](#).



Catalog Number Explanation

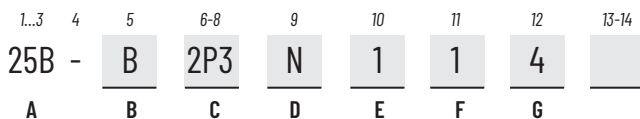

A

Drive	
Code	Type
25A	PowerFlex 523
25B	PowerFlex 525

B

Voltage Rating		
Code	Voltage	Phase
V	120V AC	1
A	240V AC	1
B	240V AC	3
D	480V AC	3
E	600V AC	3

C

Output Current @ 1 Phase, 100...120V Input						
Code	Amps	ND		HD		Frame
		HP	kW	HP	kW	
1P6	1.6	0.25	0.2	0.25	0.2	A
2P5	2.5	0.5	0.4	0.5	0.4	A
4P8	4.8	1.0	0.75	1.0	0.75	B
6P0	6.0	1.5	1.1	1.5	1.1	B

Output Current @ 1 Phase, 200...240V Input						
Code	Amps	ND		HD		Frame
		HP	kW	HP	kW	
1P6	1.6	0.25	0.2	0.25	0.2	A
2P5	2.5	0.5	0.4	0.5	0.4	A
4P8	4.8	1.0	0.75	1.0	0.75	A
8P0	8.0	2.0	1.5	2.0	1.5	B
0T1	11.0	3.0	2.2	3.0	2.2	B

Output Current @ 3Phase, 200...240V Input						
Code	Amps	ND		HD		Frame
		HP	kW	HP	kW	
1P6	1.6	0.25	0.2	0.25	0.2	A
2P5	2.5	0.5	0.4	0.5	0.4	A
5P0	5.0	1.0	0.75	1.0	0.75	A
8P0	8.0	2.0	1.5	2.0	1.5	A
0T1	11.0	3.0	2.2	3.0	2.2	A
0T7	17.5	5.0	4.0	5.0	4.0	B
024	24.0	7.5	5.5	7.5	5.5	C
032	32.2	10.0	7.5	10.0	7.5	D
048	48.3	15.0	11.0	10.0	7.5	E
062	62.1	20.0	15.0	15.0	11.0	E

C

Output Current @ 3Phase, 380...480V Input						
Code	Amps	ND		HD		Frame
		HP	kW	HP	kW	
1P4	1.4	0.5	0.4	0.5	0.4	A
2P3	2.3	1.0	0.75	1.0	0.75	A
4P0	4.0	2.0	1.5	2.0	1.5	A
6P0	6.0	3.0	2.2	3.0	2.2	A
010	10.5	5.0	4.0	5.0	4.0	B
013	13.0	7.5	5.5	7.5	5.5	C
017	17.0	10.0	7.5	10.0	7.5	C
024	24.0	15.0	11.0	15.0	11.0	D
030	30.0	20.0	15.0	15.0	11.0	D
037	37.0	25.0	18.5	20.0	15.0	E
043	43.0	30.0	22.0	25.0	18.5	E

Output Current @ 3Phase, 525...600V Input						
Code	Amps	ND		HD		Frame
		HP	kW	HP	kW	
0P9	0.9	0.5	0.4	0.5	0.4	A
1P7	1.7	1.0	0.75	1.0	0.75	A
3P0	3.0	2.0	1.5	2.0	1.5	A
4P2	4.2	3.0	2.2	3.0	2.2	A
6P6	6.6	5.0	4.0	5.0	4.0	B
9P9	9.9	7.5	5.5	7.5	5.5	C
012	12.0	10.0	7.5	10.0	7.5	C
019	19.0	15.0	11.0	15.0	11.0	D
022	22.0	20.0	15.0	15.0	11.0	D
027	27.0	25.0	18.5	20.0	15.0	E
032	32.0	30.0	22.0	25.0	18.5	E

D

Enclosure	
Code	Enclosure
N	Panel Mount - IP20 NEMA/UL Type Open

E

HIM	
Code	Interface Module
1	Standard

F

Emission Class	
Code	EMC Filter
0	No Filter
1	Filter

G

Braking	
Code	Description
4	Standard

Approximate Dimensions and Weights

Dimensions are in mm (in.) - weights are in kg (lb)

IP20, NEMA/UL Type Open

Frame	H	W	D	Weight
A	152 (5.98)	72 (2.83)	172 (6.77)	1.1 (2.4)
B	180 (7.08)	87 (3.42)	172 (6.77)	1.6 (3.5)
C	220 (8.66)	109 (4.29)	184 (7.24)	2.3 (5.1)
D	260 (10.23)	130 (5.11)	212 (8.34)	3.2 (7.1)
E	300 (11.81)	185 (7.28)	279 (10.98)	12.9 (28.4)

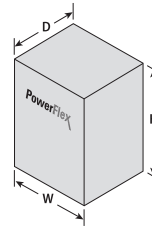

PowerFlex 527 AC Drives

0.4...22 kW/0.5...30 Hp in voltages from 100...600V

PowerFlex 527 AC drives are the first compact PowerFlex drives designed to exclusively work with a Logix controller and programmed with Studio 5000® integrated motion instructions. The PowerFlex 527 drive is an ideal AC drive to complement machines already using Kinetix® servo drives. It features a built-in dual-port for EtherNet/IP hardwired and networked safety. Using the Studio 5000 environment, the configuration and programming experience saves startup time, and delivers a coordinated and synchronized machine.

Attribute	Value
Ratings	
100...120V	0.4...1.1 kW / 0.5...1.5 Hp / 2.5...6 A
200...240V	0.4...15 kW / 0.5...20 Hp / 2.5...62.1 A
380...480V	0.4...22 kW / 0.5...30 Hp / 1.4...43 A
525...600V	0.4...22 kW / 0.5...30 Hp / 0.9...32 A
Motor Control	<ul style="list-style-type: none"> VHz Control Closed Loop Velocity Vector Control Sensorless Vector Control
Enclosures	<ul style="list-style-type: none"> IP20, NEMA/UL Type Open IP30, NEMA/UL Type 1 (with optional kit)
Safety	Built-in safety—hardwired or networked Safe Torque Off
Communication Options	Built-in dual-port for EtherNet/IP
Additional Features	<ul style="list-style-type: none"> Automatic Device Configuration Economizer motor control Conformal coating to IEC 60721 3C2 standards Optional encoder card

1. LCD QuickView® Human Interface Module (HIM) with multi-language support in scrolling text.
2. Choice of built-in hardwired or networked safety SIL 3, PLe, CAT 3. Built-in safety simplifies machine design and minimizes equipment redundancies.
3. Works exclusively with Logix controller. Program with motion instruction in the Studio 5000 Logix Designer® application allows a common user experience.
4. Communications: Built-in dual-port for EtherNet/IP.

For accessories and options, including HIMs and communication options, see PowerFlex 527 AC Drive Specifications Technical Data, [520-TD002](#).

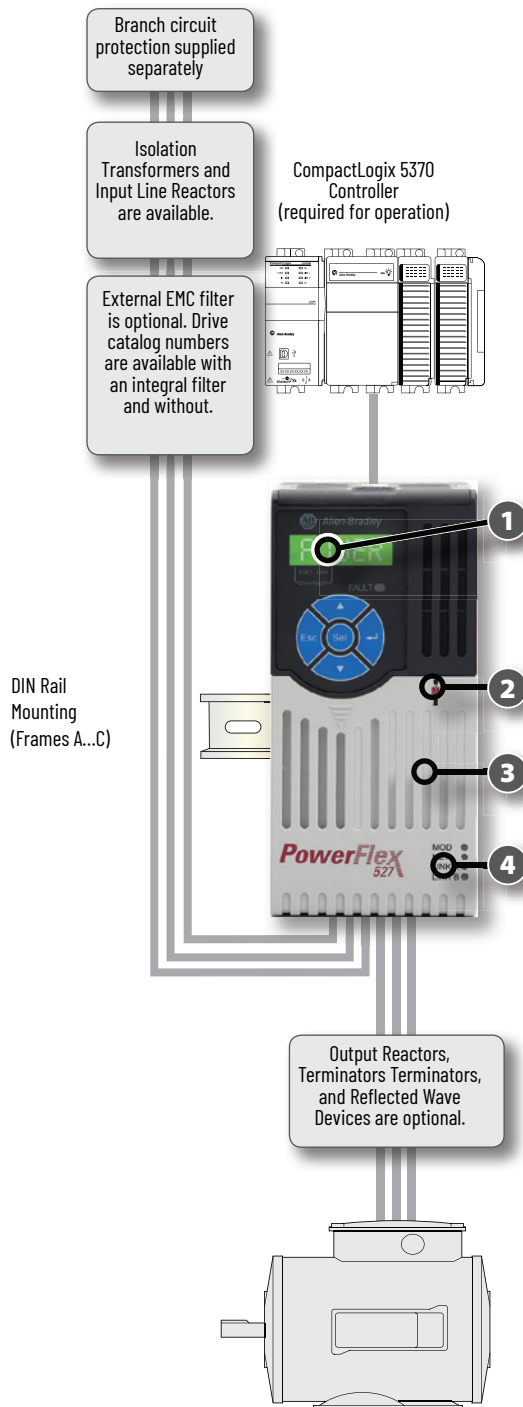

Requires a Logix controller capable of supporting Motion Instructions at a minimum firmware revision of 24.

Catalog Number Explanation

1...3 4 5 6-8 9 10 11 12 13-14
 25C - B 2P3 N 1 1 4
 A B C D E F G

A

Drive	
Code	Type
25C	PowerFlex 527

B

Voltage Rating		
Code	Voltage	Phase
V	120V AC	1
A	240V AC	1
B	240V AC	3
D	480V AC	3
E	600V AC	3

C

Output Current @ 1 Phase, 100...120V Input						
Code	Amps	ND		HD		Frame
		HP	kW	HP	kW	
2P5	2.5	0.5	0.4	0.5	0.4	A
4P8	4.8	1.0	0.75	1.0	0.75	B
6P0	6.0	1.5	1.1	1.5	1.1	B

Output Current @ 1 Phase, 200...240V Input						
Code	Amps	ND		HD		Frame
		HP	kW	HP	kW	
2P5	2.5	0.5	0.4	0.5	0.4	A
4P8	4.8	1.0	0.75	1.0	0.75	A
8P0	8.0	2.0	1.5	2.0	1.5	B
011	11.0	3.0	2.2	3.0	2.2	B

Output Current @ 3Phase, 200...240V Input						
Code	Amps	ND		HD		Frame
		HP	kW	HP	kW	
2P5	2.5	0.5	0.4	0.5	0.4	A
5P0	5.0	1.0	0.75	1.0	0.75	A
8P0	8.0	2.0	1.5	2.0	1.5	A
011	11.0	3.0	2.2	3.0	2.2	A
017	17.5	5.0	4.0	5.0	4.0	B
024	24.0	7.5	5.5	7.5	5.5	C
032	32.2	10.0	7.5	10.0	7.5	D
048	48.3	15.0	11.0	10.0	7.5	E
062	62.1	20.0	15.0	15.0	11.0	E

C

Output Current @ 3Phase, 380...480V Input						
Code	Amps	ND		HD		Frame
		HP	kW	HP	kW	
1P4	1.4	0.5	0.4	0.5	0.4	A
2P3	2.3	1.0	0.75	1.0	0.75	A
4P0	4.0	2.0	1.5	2.0	1.5	A
6P0	6.0	3.0	2.2	3.0	2.2	A
010	10.5	5.0	4.0	5.0	4.0	B
013	13.0	7.5	5.5	7.5	5.5	C
017	17.0	10.0	7.5	10.0	7.5	C
024	24.0	15.0	11.0	15.0	11.0	D
030	30.0	20.0	15.0	15.0	11.0	D
037	37.0	25.0	18.5	20.0	15.0	E
043	43.0	30.0	22.0	25.0	18.5	E

Output Current @ 3Phase, 525...600V Input						
Code	Amps	ND		HD		Frame
		HP	kW	HP	kW	
0P9	0.9	0.5	0.4	0.5	0.4	A
1P7	1.7	1.0	0.75	1.0	0.75	A
3P0	3.0	2.0	1.5	2.0	1.5	A
4P2	4.2	3.0	2.2	3.0	2.2	A
6P6	6.6	5.0	4.0	5.0	4.0	B
9P9	9.9	7.5	5.5	7.5	5.5	C
012	12.0	10.0	7.5	10.0	7.5	C
019	19.0	15.0	11.0	15.0	11.0	D
022	22.0	20.0	15.0	15.0	11.0	D
027	27.0	25.0	18.5	20.0	15.0	E
032	32.0	30.0	22.0	25.0	18.5	E

D

Enclosure	
Code	Enclosure
N	Panel Mount - IP20 NEMA/UL Type Open

E

HIM	
Code	Interface Module
1	Standard

F

Emission Class	
Code	EMC Filter
0	No Filter
1	Filter

G

Braking	
Code	Description
4	Standard

Approximate Dimensions and Weights

Dimensions are in mm (in.) - weights are in kg (lb)

IP20, NEMA/UL Type Open

Frame	H	W	D	Weight
A	152 (5.98)	72 (2.83)	172 (6.77)	1.1 (2.4)
B	180 (7.08)	87 (3.42)	172 (6.77)	1.6 (3.5)
C	220 (8.66)	109 (4.29)	184 (7.24)	2.3 (5.1)
D	260 (10.23)	130 (5.11)	212 (8.34)	3.2 (7.1)
E	300 (11.81)	185 (7.28)	279 (10.98)	12.9 (28.4)

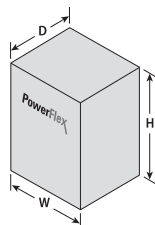

PowerFlex 70 AC Drives

0.37...37 kW/0.5...50 Hp in voltages from 200...600V

The PowerFlex 70 offers a compact package of power, control and operator interface, which is designed to meet the demands for space, simplicity, and reliability. This drive provides a broad spectrum of features, allowing you to easily integrate it into your architecture and configure it for most application needs.

Attribute	Value
Ratings	200...240V 0.37...18.5 kW / 0.5...25 Hp / 2.2...70 A 380...480V 0.37...37 kW / 0.5...50 Hp / 1.1...72 A 500...600V 0.5...50 Hp / 0.9...52 A
Motor Control	<ul style="list-style-type: none"> VHz Control Sensorless Vector Control Vector Control with FORCE Technology (with and without encoder)
Enclosures	<ul style="list-style-type: none"> IP20, NEMA/UL Type 1 Flange Mount IP54, NEMA/UL Type 12 IP66, NEMA/UL Type 4X/12 for indoor use

- LCD Programmer shown (not supplied).
- Multiple communication options for industrial networks are available.
- 24V DC I/O Standard. 6 digital inputs, 2 analog inputs, 2 relay outputs, and 1 analog output. 115V interface is available.
- Integral dynamic brake transistor. Internal and external resistors are available.

For accessories and options, including HIMs and communication options, see PowerFlex 70 Adjustable Frequency AC Drive Specifications Technical Data, [20A-TD001](#).

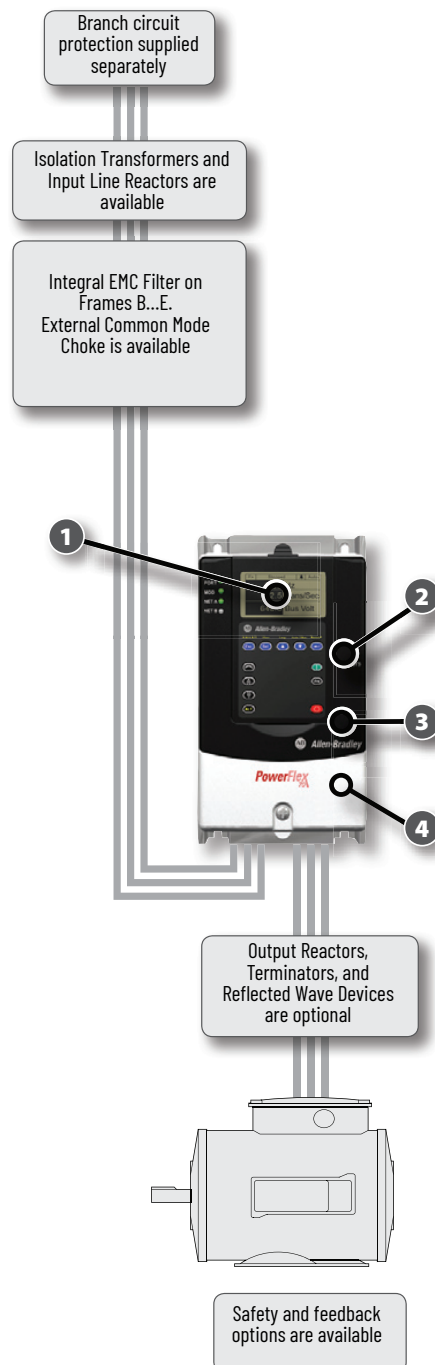

Catalog Number Explanation

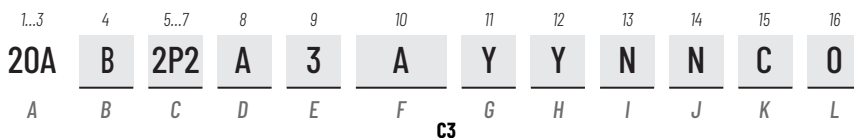

A	
Drive	
Code	Type
20 A	PowerFlex 70

B		
Voltage Rating		
Code	Voltage	Ph.
B	240V AC	3 (6 pulse)
C	400V AC	3 (6 pulse)
D	480V AC	3 (6 pulse)
E	600V AC	3 (6 pulse)

C1				
PowerFlex 70 ND Rating				
208V, 60 Hz Input				
Code	208V amps	kW	Hp	Frame
2P2	2.5	0.37	0.5	A
4P2	4.8	0.75	1.0	
6P8	7.8	1.5	2.0	B
9P6	11	2.2	3.0	C
015	17.5	4.0	5.0	
022	25.3	5.5	7.5	D
028	32.2	7.5	10	
042	43	11	15	E
054	56	15	20	
070	78.2	18.5	25	

C2				
PowerFlex 70 ND Rating				
240V, 60 Hz Input				
Code	Amps	kW	Hp	Frame
2P2	2.2	0.37	0.5	A
4P2	4.2	0.75	1.0	
6P8	6.8	1.5	2.0	B
9P6	9.6	2.2	3.0	C
015	15.3	4.0	5.0	
022	22	5.5	7.5	D
028	28	7.5	10	
042	42	11	15	E
054	54	15	20	
070	70	18.5	25	

H				
Internal Brake Resistor				
Code	w/ Resistor			
Y	Yes			
N	No			

J	
Comm Slot	
Code	Network Type
C	ControlNet (Coax)
D	DeviceNet
E	EtherNet/IP
N	None

K		
Control and I/O		
Code	Control	Safe Torque Off
C	Enhanced	No
G	Enhanced	Yes

PowerFlex 70 ND Rating				
400V, 50 Hz Input				
Code	Amps	kW	Hp	Frame
1P3	1.3	0.37	0.5	A
2P1	2.1	0.75	1.0	
3P5	3.5	1.5	2.0	
5P0	5.0	2.2	3.0	B
8P7	8.7	4.0	5.0	
011	11.5	5.5	7.5	C
015	15.4	7.5	10	
022	22	11	15	D
030	30	15	20	
037	37	18.5	25	E
043	42	22	30	
060	60	30	40	
072	72	37	50	

C4				
PowerFlex 70 ND Rating				
480V, 50 Hz Input				
Code	Amps	kW	Hp	Frame
1P1	1.1	0.37	0.5	A
2P1	2.1	0.75	1.0	
3P4	3.4	1.5	2.0	
5P0	5.0	2.2	3.0	B
8P0	8.0	3.7	5.0	
011	11	5.5	7.5	C
014	14	7.5	10	
022	22	11	15	D
027	27	15	20	
034	34	18.5	25	E
040	40	22	30	
052	52	30	40	
065	65	37	50	

I	
Emission Class	
Code	Rating
A	Filtered
N	Not Filtered

Emission Class by Frame Current Rating (A...E) and Voltage					
	A ⁽¹⁾⁽²⁾	B ⁽²⁾	C	D	E
240V	A or N	A or N	A	A	A
400V	A or N	A or N	A	A	A
480V	A or N	A or N	A	A	A
600V	N	N	N	N	A

- (1) If a filter is used with a Frame A current rating, the drive with internal filter is supplied in the B Frame to accommodate the additional size.
- (2) "A or N" indicates that filtering is optional.

C5				
PowerFlex 70 ND Rating				
600V, 60 Hz Input ⁽¹⁾				
Code	Amps	kW	Hp	Frame
0P9	0.9	0.37	0.5	A
1P7	1.7	0.75	1.0	
2P7	2.7	1.5	2.0	
3P9	3.9	2.2	3.0	B
6P1	6.1	4.0	5.0	
9P0	9.0	5.5	7.5	C
011	11	7.5	10	
017	17	11	15	D
022	22	15	20	
027	27	18.5	25	E
032	32	22	30	
041	41	30	40	
052	52	37	50	

- (1) 600V class drives are declared to meet the Low Voltage Directive. It is the responsibility of the user to determine compliance to the EMC Directive.

D	
Enclosure	
Code	Description
A ⁽¹⁾	Panel Mount - IP 20, NEMA/UL Type 1
C ⁽¹⁾	Wall/Machine Mount = IP66, NEMA/UL Type 4X/12 for indoor use only
F	Flange Mount - Front Chassis = IP 20, NEMA/UL Type 1; Rear Heatsink = IP66, NEMA/UL Type 4X/12 for indoor use only
G	Wall/Machine Mount - IP54, NEMA/UL Type 12 ⁽²⁾

- (1) IP20 and IP66 frame E drives are manufactured with a flange-like heat sink with mounting holes.
- (2) Only available on Frame E.

E	
HIM	
Code	Interface Module
0	Blank Cover
3	Full Numeric LCD
5	Prog. Only LCD ⁽¹⁾

- (1) Only available with NEMA 4X, enclosure C.

F	
Documentation	
Code	Description
A	Manual
N	No manual

G	
Brake IGBT	
Code	w/Brake
Y	Yes

L	
Feedback	
Code	Description
0	No Feedback
1	5V/12V Encoder ⁽¹⁾

- (1) Drive is not CE EMC certified when the encoder interface option is installed

Approximate Dimensions and Weights

Dimensions are in mm (in.) - weights are in kg (lb)

IP20, NEMA/UL Type 1

Frame	H	W	D	Weight
A	225.7 (8.89)	122.4 (4.82)	179.8 (7.08)	2.71 (6)
B	234.6 (9.24)	171.7 (6.76)		3.6 (7.9)
C	300 (11.81)	185 (7.28)		6.89 (15.2)
D	350 (13.78)	219.9 (8.66)		9.25 (20.4)
E	555.8 (21.88)	280.3 (11.04)	207.1 (8.15)	18.6 (41)

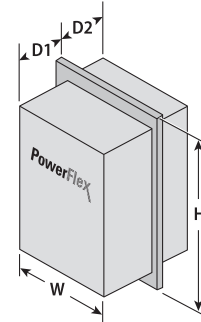
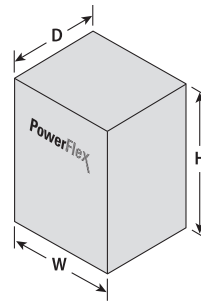

IP66, NEMA/UL Type 4X/12 for Indoor Use

Frame	H	W	D	Weight
B	239.8 (9.44)	171.7 (6.76)	203.3 (8)	3.61 (8)
D	350 (13.78)	219.9 (8.66)	210.7 (8.29)	9.13 (20.1)
E	555.8 (21.88)	280.3 (11.04)	219.8 (8.65)	18.6 (41)

Flange Mount

Frame	H	W	D1	D2	Weight
A	225.8 (8.89)	156 (6.14)	123 (4.84)	55.6 (2.19)	2.71 (6)
B	234.6 (9.24)	205.2 (8.08)			3.6 (7.9)
C	300 (11.81)	219 (8.62)			6.89 (15.2)
D	350 (13.78)	248.4 (9.78)			9.25 (20.4)
E	555.8 (21.88)	280.3 (11.04)	117.2 (4.61)	89.9 (3.54)	18.6 (41)

PowerFlex 700 AC Drive



Designed to meet global OEM and end-user demands for simplicity, space savings, and cost efficiency, this drive provides intuitive features such as an integral keypad with local potentiometer and control keys that are active right out of the box.

Attribute	Value
Ratings 200...240V 380...480V 500...600V 690V	0.37...66 kW / 0.5...100 Hp / 2.2...260 A 380...480V: 0.37...132 kW / 0.5...200 Hp / 1.1...260 A 1...150 Hp / 1.7...144 A 45...132 kW / 52...142 A
Motor Control	VHz Control Sensorless Vector Control Vector Control with FORCETechnology (with and without encoder)
Enclosures	<ul style="list-style-type: none"> • IP20, NEMA / UL Type 1 • IP54, NEMA 12 • Flange Mount

For accessories and options, including HIMs and communication options, see PowerFlex 700 Adjustable Frequency AC Drive Specifications Technical Data, [20B-TD001](#).

PowerFlex 700S AC Drives



The PowerFlex 700S offers optimized integration for the most demanding standalone and coordinated drive control and drive system applications. The DriveLogix™ option combines the powerful performance and flexible control of PowerFlex AC drives with a high-performance Logix engine to produce a highly functional, cost-effective drive and control solution.

Attribute	Value
Ratings 200...240V 380...480V 500...600V 690V	0.75...66 kW / 1...100 Hp / 4.2...260 A 380...480V: 0.75... 132kW / 1... 200 Hp / 2.1... 260 A 500... 600V: 1... 150 Hp / 1.7...144A 690V: / 45...132kW/ 52...142A
Motor Control	VHz Control Vector Control with FORCETechnology (with and without encoder) Permanent Magnet Motor Control
Enclosures	<ul style="list-style-type: none"> • IP20, NEMA / UL Type 1

For accessories and options, including HIMs and communication options, see PowerFlex 700S Drive with Phase II Control Specifications Technical Data, [20D-TD002](#).

PowerFlex 753 AC Drives

0.37...270 kW/0.5...400 Hp in voltages from 200...690V

Designed for general-purpose applications, the PowerFlex 753 AC drive offers multiple options and features along with the added benefit of simple integration. The PowerFlex 753 comes standard with built-in I/O, making it a cost-effective solution ideal for OEMs and system integrators looking to reduce engineering costs, deliver machines to market faster and meet end-user demand for more productive and safer machines.

Attribute	Value
Ratings 200...240V 380...480V 575...600V 690V	0.37...132 kW/0.5...200 Hp / 2.2...477 A 0.75...270 kW / 1.0...400 Hp / 2.1...477 A 1.0...300 Hp / 1...289 A 7.5...250 kW / 12...263 A
Motor Control	<ul style="list-style-type: none"> • VHz Control • Sensorless Vector Control • Vector Control with FORCE Technology (with and without encoder) • Interior Permanent Magnet
Enclosures	<ul style="list-style-type: none"> • IP00/IP20, NEMA/UL Type Open • Flange Mount • IP54, NEMA/UL Type 12
Safety	<ul style="list-style-type: none"> • Safe Torque Off SIL 3, PLe, CAT 3 • Safe Speed Monitor SIL 3, PLe, CAT 4
Additional Features	<ul style="list-style-type: none"> • Automatic Device Configuration • DeviceLogix™ • Adjustable Voltage Control • Indexing • Pump Jack and Pump Off for oil well applications • Pump and Traverse for fibers applications • Conformal Coating

1. LCD Human Interface Module (HIM) with multi-language support in scrolling text available as optional accessory.
2. Multiple communication options for industrial networks available.
3. Embedded I/O: 3 digital inputs, 1 relay output, 1 transistor output, 1 analog input, 1 analog output, and 1 PTC input.
4. Integral brake resistor on Frames 1...5, optional on Frames 6...7. Resistors are available.

For accessories and options, including HIMs and communication options, see PowerFlex 750-Series AC Drive Specifications Technical Data, [750-TD001](#).

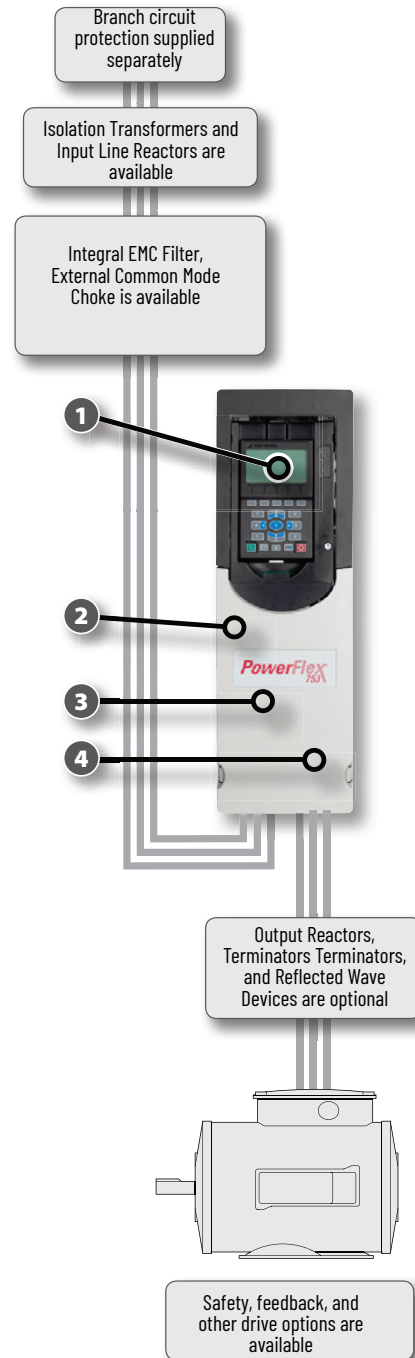

Catalog Number Explanation - PowerFlex 753 and PowerFlex 755



A		
Drive		
Code	Type	Frames
20F	PowerFlex® 753	1...7
20G	PowerFlex 755	1...10
21G	PowerFlex 755 Drive with Options	8...10

B		
Future Use		

C		
Input Type		
Code	Description	Frames
1	AC Input with Precharge, includes DC Terminals	1...5 8...10
4	DC Input with Precharge	5...10
A	AC Input with Precharge, no DC Terminals	6...8 ⁽¹⁾

(1) The DC Bus Bar kit (20-750-DCBB1-Fx) is available for Frames 6...7 AC input drives that require DC bus terminals.

D		
Enclosure		
Code	Description	Frames
R	IP20, NEMA/UL Type Open, Frame 1	1
F ⁽¹⁾	Flange (NEMA/UL Type 4X/12 back)	2...5
G	IP54, NEMA/UL Type 12	2...7
N ⁽²⁾	IP20/IP00, NEMA/UL Type Open	2...7
B ⁽³⁾	IP20, NEMA/UL Type 1, 600 mm (23.6 in.) Deep, Standard Cabinet Color (RAL 7032)	8...10
J ⁽³⁾	IP54, UL Type 12, 800 mm (31.5 in.) Deep, Standard Cabinet Color (RAL 7032)	8...10
K ⁽³⁾	IP54, NEMA 12, 2500 MCC Style Cabinet and Options w/MCC Power Bus, 800 mm (31.5 in.) Deep, Standard Cabinet Color (RAL 7032)	8...10
L ⁽³⁾	IP20, NEMA/UL Type 1, 800 mm (31.5 in.) Deep, Standard Cabinet Color (RAL 7032)	8...10
p ⁽³⁾	IP20, NEMA/UL Type 1, 2500 MCC Style Cabinet and Options w/MCC Power Bus, 800 mm (31.5 in.) Deep, Standard Cabinet Color (RAL 7032)	8...10
W ⁽³⁾	IP20, NEMA/UL Type 1, 2500 MCC Style Cabinet and Options w/MCC Power Bus, 800 mm (31.5 in.) Deep, CenterLine 2100 Gray (ASA49)	8...10
Y ⁽³⁾	IP54, NEMA 12, 2500 MCC Style Cabinet and Options w/MCC Power Bus, 800 mm (31.5 in.) Deep, CenterLine 2100 Gray (ASA49)	8...10
T	IP00, UL Open Type without Control POD	8...10

- (1) For Frames 6...7, a user installed flange kit is available to convert a Code N drive that provides a NEMA/UL Type 4X/12 back.
- (2) Frames 2...5 are IP20, Frames 6...7 are IP00.
- (3) Available as a drive with options (21G).

E	
Voltage Rating	
Code	Voltage
B	240V AC (208V AC) ⁽¹⁾ / 325V DC (281V DC) ⁽¹⁾
C	400V AC/540V DC
D	480V AC/650V DC
E	600V AC/810V DC
F	690V AC/932V DC (not UL Listed)

(1) Drive must be programmed to obtain low (208V AC) voltage rating.

F1								
ND Rating								
208V ⁽¹⁾ 208V, 60 Hz Input								
Code	Amps	kW	Frame					
			Enclosure Code					
			B, J, L, T	F	G	N	K, P, W, Y	R
2P2	2.5	0.37						
4P2	4.8	0.75						
6P8	7.8	1.5						
9P6	11	2.2						
015	15.3	4						
2P2	2.5	0.37						
4P2	4.8	0.75						
6P8	7.8	1.5						
9P6	11	2.2						
015	17.5	4						
022	22	5.5						
028	32.2	7.5						
042	43	11						
054	60	15						
070	78.2	18.2						
080	92	22						
104	120	30						
130	150	37						
154	177	45						
192	221	55						
260	260	66						
312	359	90						
360	414	110						
477	477	132						

- (1) Drive must be programmed to obtain low (208VAC) voltage rating.
- (2) For Frames 6 and 7, a user-installed flange kit is available to convert a Code N drive that provides a NEMA/UL Type 4X/12 back.

F2								
ND Rating								
240V, 60 Hz Input								
Code	Amps	Hp	Frame					
			Enclosure Code					
			B, J, L, T	F	G	N	K, P, W, Y	R
2P2	2.2	0.5						
4P2	4.2	1						
6P8	6.8	2						
9P6	9.6	3						
015	15.3	5						
2P2	2.2	0.5						
4P2	4.2	1						
6P8	6.8	2						
9P6	9.6	3						
015	15.3	5						
022	22	7.5						
028	28	10						
042	42	15						
054	54	20						
070	70	25						
080	80	30						
104	104	40						
130	130	50						
154	154	60						
192	192	75						
260	260	100						
312	312	125						
360	360	150						
477	477	200						

(1) For Frames 6 and 7, a user-installed flange kit is available to convert a Code N drive that provides a NEMA/UL Type 4X/12 back.

1...3 **20G** 4 **1** 5 **A** 6 **N** 7 **D** 8...10 **248** 11 **A** 12 **A** 13 **O** 14 **N** 15 **N** 16 **N** 17 **N** 18 **N** **LD - P3 - P11...**

A B C D E F1...F6 G H I Positions 14...18 are not used.

F3							
ND Rating							
400V, 50 Hz Input							
Code	Amps	kW	Frame				R
			Enclosure Code				
			B, J, L, T	F	G	N	
2P1	2.1	0.75					1
3P5	3.5	1.5					
5P0	5.0	2.2					
8P7	8.7	4		2	2	2	
011	11.5	5.5					
015	15.4	7.5					
022	22	11					
030	30	15					
037	37	18.5		3	3	3	
043	43	22					
060	60	30	-	4	4	4	-
072	72	37			5		
085	85	45		5		5	
104	104	55					
140	140	75			6		
170	170	90				6	
205	205	110					
260	260	132		(1)			
302	302	160			7	7	
367	367	200					
456	456	250					
460	460	250	8	-	-	-	8 ⁽²⁾
477	477	270	-	(1)	-	7	-
540	540	315					
567	567	315					
650	650	355	8				8 ⁽²⁾
750	750	400					
770	770	400					
910	910	500					
1K0	1040	560					
1K1	1090	630					
1K2	1175	710	9				9 ⁽²⁾
1K4	1465	800					
1K5	1480	850					
1K6	1590	900					
2K1	2150	1250	10				10 ⁽²⁾

(1) For Frames 6...7, a user installed flange kit (20-750-FLNG4-Fx) is available to convert a Code N drive that provides a NEMA/UL Type 4X/12 back.
 (2) Available as a drive with options (21G).

F4							
ND Rating							
480V, 60 Hz Input							
Code	Amps	Hp	Frame				R
			Enclosure Code				
			B, J, L, T	F	G	N	
2P1	2.1	1					
3P4	3.4	2					
5P0	5.0	3					
8P0	8.0	5		2	2	2	1
011	11	7.5					
014	14	10					
022	22	15					
027	27	20					
034	34	25		3	3	3	
040	40	30					
052	52	40	-	4	4	4	-
065	65	50			5		
077	77	60		5		5	
096	96	75					
125	125	100			6		
156	156	125				6	
186	186	150					
248	248	200		(1)			
302	302	250			7	7	
361	361	300					
415	415	350					
430	430	350	8	-	-	-	8 ⁽²⁾
477	477	400	-	(1)	-	7	-
485	485	400					
545	545	450					
617	617	500	8				8 ⁽²⁾
710	710	600					
740	740	650					
800	800	700					
960	960	800					
1K0	1045	900	9				9 ⁽²⁾
1K2	1135	1000					
1K3	1365	1100					
1K4	1420	1250					
1K5	1525	1350					
2K0	2070	1750	10				10 ⁽²⁾

(1) For Frames 6...7, a user installed flange kit (20-750-FLNG4-Fx) is available to convert a Code N drive that provides a NEMA/UL Type 4X/12 back.
 (2) Available as a drive with options (21G).

F5							
ND Rating							
600V, 60 Hz Input							
Code	Amps	Hp	Frame				R
			Enclosure Code				
			B, J, L, T	F	G	N	
1P7	1.7	1					
2P7	2.7	2					
3P9	3.9	3					
6P1	6.1	5		3	3	3	
9P0	9	7.5					
011	11	10					
012 ⁽¹⁾	12	10		-	6	6	
017	17	15		3	3	3	
018 ⁽¹⁾	18	15		-	6	6	
022	22	20		3	3	3	
023 ⁽¹⁾	23	20		-	6	6	
024 ⁽¹⁾	24	20					
027	27	25		4	4	4	
028 ⁽¹⁾	28	25	-	-	6	6	-
032	32	30		4	4	4	
033 ⁽¹⁾	33	30		-	6	6	
041	41	40		5	5	5	
042 ⁽¹⁾	42	40		-	6	6	
052	52	50		5	-	5	
053 ⁽¹⁾	53	50					
063	63	60					
077	77	75					
099	99	100			6	6	
125	125	125		(2)			
144	144	150					
192	192	200					
242	242	250			7	7	
289	289	300					
295	295	300					
355	355	350					
395	395	400					
435	435	450					
460	460	500					
510	510	500					
595	595	600					
630	630	700					
760	760	800					
825	825	900					
900	900	950					
980	980	1000					
1K1	1110	1100					
1K4	1430	1400	10				10 ⁽³⁾

(1) Required for uncontrolled common DC bus applications. Optional for all AC applications.
 (2) For Frames 6...7, a user installed flange kit (20-750-FLNG4-Fx) is available to convert a Code N drive that provides a NEMA/UL Type 4X/12 back.
 (3) Available as a drive with options (21G).

1...3 4 5 6 7 8...10 11 12 13 14 15 16 17 18
20G 1 A N D 248 A A O N N N N N LD - P3 - P11...
 A B C D E F1...F6 G H I Positions 14...18 are not used.

F6									
ND Rating									
690V, 50 Hz Input (not UL Listed)									
Code	Amps	kW	Frame						
			Enclosure Code						
			B, J, L, T	F	G	N	K, P, W, Y	R	
012	12	7.5							
015	15	11							
020	20	15							
023	23	18.5							
030	30	22							
034	34	30							
046	46	37			6	6			
050	50	45							
061	61	55							
082	82	75							
098	98	90							
119	119	110							
142	142	132							
171	171	160							
212	212	200			7	7			
263	263	250							
265	265	250							
330	330	315							
370	370	355							
415	415	400							
460	460	450							
500	500	500							
590	590	560							
650	650	630							
710	710	710							
765	765	750							
795	795	800							
960	960	900							
1K0	1040	1000							
1K4	1400	1400							

(1) For Frames 6...7, a user installed flange kit (20-750-FLNG4-Fx) is available to convert a Code N drive that provides a NEMA/UL Type 4X/12 back.
 (2) Available as a drive with options (21G).

G		
Filtering and CM Cap Configuration		
Code	Filtering	Default CM Cap Connection
A	Yes	Jumper Removed
J	Yes	Jumper Installed

H		
Dynamic Braking ⁽¹⁾		
Code	Internal Resistor ⁽²⁾	Internal Transistor ⁽³⁾
A	No	Yes
N	No	No

(1) Not available on Frames 8...10, specify Code 'N'.
 (2) Frames 1...2 only. Internal Resistor kits (20-750-DB1-Dx) sold separately.
 (3) Standard on Frames 1...5, optional on 6...7.

I	
Door Mounted HIM (Frames 8...10)	
Code	Operator Interface
0	No Door Mounted HIM
2	Enhanced LCD, Full Numeric, IP20
4	Enhanced LCD, Full Numeric, IP66 NEMA Type 4X/12

PowerFlex 755 w/Options (21G) Required Selections			
Code	Option	Frames	Type
LD	Light Duty	8...10	System Overload Duty Cycle ⁽¹⁾
ND	Normal Duty		
HD	Heavy Duty		
P3	Input Thermal-magnetic Circuit Breaker	8...10	Power Disconnect ⁽¹⁾
P5	Input Non-Fused Molded Case Disconnect Switch	8 Only	
P14	Wiring Only Bay	8...10	Wiring Only Bay

(1) Only one option of this type can be selected.

PowerFlex 755 w/Options (21G) Additional Selections			
Code	Option	Frames	Type
P11	Input Contactor	8 Only	Contactors ⁽¹⁾ (2)
P12	Output Contactor		
L1	3% Input Reactor	8...9	Reactors ⁽¹⁾
L2	3% Output Reactor		
L3	5% Input Reactor		
L4	5% Output Reactor		
P20	1200 A Bus	8...10	MCC Power Bus Capacity ⁽¹⁾
P22	2000 A Bus		
P24	3000 A Bus		
P30	UPS Control Bus, DC Input w/Precharge only	8...10	UPS Control Bus
X1	Auxiliary Transformer (500VA available), IP20 Cabinet Only	8 Only ⁽³⁾	Auxiliary Power

(1) Only one option of this type can be selected.
 (2) Contactor options are not available for systems with MCC power bus.
 (3) Standard on all other cabinet configurations.

Approximate Dimensions and Weights

Dimensions are in mm (in.) - weights are in kg (lb)

IP00/IP20, NEMA/UL Type Open

Frame	H	W	D	Weight
1	400.5 (15.77)	110 (4.33)	211 (8.31)	6 (12.75)
2	424.2 (16.7)	134.5 (5.3)	212 (8.35)	7.8 (17.2)
3	454 (17.87)	190 (7.48)		11.8 (26.1)
4	474 (18.66)	222 (8.74)		13.6 (30)
5	550 (21.65)	270 (10.63)		20.4 (45)
6	665.5 (26.2)	308 (12.13)	346.4 (13.64)	38.6 (85)
7	881.5 (34.7)	430 (16.93)	349.6 (13.76)	72.6...108.9 (160...240)

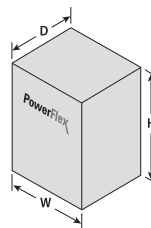

IP54, NEMA/UL Type 12

Frame	H	W	D	Weight
2	543.2 (21.39)	215.3 (8.48)	222.2 (8.75)	8 (17)
3	551 (21.69)	268 (10.55)	220.1 (8.67)	12 (26)
4	571 (22.48)	300 (11.81)		14 (30)
5	647 (25.47)	348.0 (13.7)		20 (45)
6	1298.3 (51.11)	609.4 (24)	464.7 (18.3)	91 (200)
7	1614 (63.54)			162 (357)

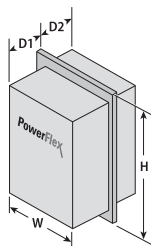

Flange Mount

Frame	H	W	D1	D2	Weight
2	481.8 (18.97)	206.2 (8.12)	148.3 (5.84)	63.7 (2.51)	8 (17)
3	515 (20.28)	260 (10.24)	127.4 (5.02)	84.6 (3.33)	12 (26)
4	535 (21.06)	292 (11.5)			14 (30)
5	611 (24.06)	340 (13.39)			20 (45)
6	665.5 (26.2)	308 (12.13)	208.4 (8.2)	138 (5.43)	38 (84)
7	875 (34.45)	430 (16.93)			96 (212)

PowerFlex 755 AC Drives

0.37...1500 kW/1...2000 Hp in voltages from 200...690V

Designed for flexibility, connectivity, and productivity, the PowerFlex 755 AC drive provides ease of use and high performance for a wide variety of motor control applications. Ideal for machines that benefit from safety options, application flexibility, and packaging that is designed to meet various environmental conditions, the PowerFlex 755 drive offers more selection for control, communications, safety, and supporting hardware options than any other drives in its class.

Attribute	Value
Ratings	200...240V 380...480V 600V 690V
	0.37...132 kW / 0.5...200 Hp / 2.2...477 A 0.75...1400 kW / 1.0...2000 Hp / 2.1...2330 A 1.0...1500 Hp / 1.7...1530 A 7.5...1500 kW / 12...1485 A
Motor Control	<ul style="list-style-type: none"> VHz Control Sensorless Vector Control Vector Control with FORCE Technology (with and without encoder) Surface Mount Permanent Magnet: Frames 1...7 (with and without encoder) Frames 8...10 (with encoder) Interior Permanent Magnet: Frames 1...7 (with and without encoder) Frames 8...10 (with encoder)
Enclosures	<ul style="list-style-type: none"> IP00/IP20, NEMA/UL Type Open Flange Mount IP54, NEMA/UL Type 12 IP20, NEMA/UL Type 1 (MCC Style Cabinet) IP54, NEMA Type 12 (MCC Style Cabinet)
Safety	<ul style="list-style-type: none"> Hardwired Safe Torque Off SIL 3, PLe, CAT 3 Hardwired Safe Speed Monitor SIL 3, PLe, CAT 4 Networked Safe Torque Off SIL 3, PLe, CAT 3
Communication Options	Built-in EtherNet/IP Port
Additional Features	<ul style="list-style-type: none"> Automatic Device Configuration DeviceLogix™ Adjustable Voltage Control TorqProve™ for lifting applications Pump Jack and Pump Off for oil well applications Pump and Traverse for fibers applications Conformal Coating

For accessories and options, including HIMs and communication options, see PowerFlex 750-Series AC Drive Specifications Technical Data, [750-TD001](#).

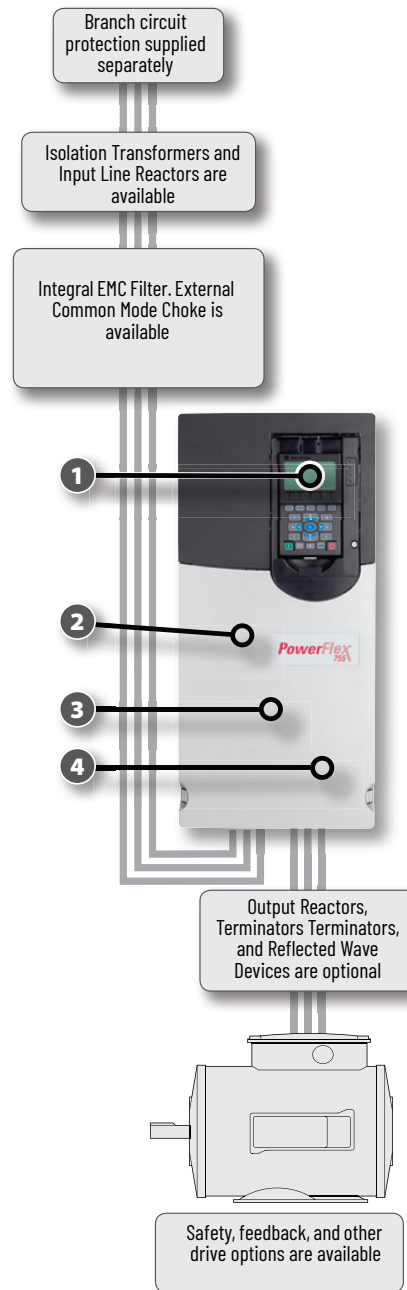

1. LCD HIM with multi-language support in scrolling text available as optional accessory.
2. Communications: Embedded EtherNet/IP.
3. Embedded I/O: 1 Digital Input.
4. Integral brake transistor on Frames 1...5, optional on Frames 6...7. Resistors are available. See [Catalog Number Explanation - PowerFlex 753 and PowerFlex 755 on page 38](#).

PowerFlex 755 Wall Mount Drives

PowerFlex 755 wall mount drives have a power range from 0.75 kW / 1 Hp to 270 kW / 400 Hp and are available in several factory and field installable enclosure options to meet most environmental requirements.

The standard enclosure is optimized for cabinet installation and rated at IP00/IP20, NEMA/UL Type Open. Wall mount drives can be converted to IP20, NEMA/UL Type 1 with an optional kit containing a debris hood and conduit plate. A factory enclosure option is also available with extra protection (IP54, NEMA Type 12) for harsh environments.

Flange mount drives are available via a factory option (Frames 1...5) or field installable kits (Frames 6...7) and are designed to reduce panel cooling requirements by mounting the drive heatsink outside the cabinet.

A DC link choke is included on all frames and internal brake transistor in standard on Frames 1...5 and optional on Frames 6...7.



PowerFlex 755 Floor Mount Drives

PowerFlex 755 floor mount drives have a power range from 200 kW / 250 Hp to 1400 kW / 2000 Hp, and offer multiple duty ratings to provide flexibility for different application requirements. One drive can provide three different motor current ratings. For example a 480 A drive can run a 400 Hp motor in light duty, a 350 Hp motor in normal duty, and a 300 Hp motor in heavy duty.

- Light Duty = 110% of motor rated current for 60 seconds
- Normal Duty = 110% of motor rated current for 60 seconds/150% of motor rated current for 3 seconds
- Heavy Duty = 150% of motor rated current for 60 seconds/180% of motor rated current for 3 seconds

Other power options from the factory include disconnect, reactor, contactor, integrated MCC bus for direct connection to CENTERLINE® MCC, auxiliary transformer, or wiring bay.



Power Options for PowerFlex 755 Floor Mount, AC Input Drives

Pre-engineered, factory-installed options are available with the PowerFlex 755 floor mount drives, which includes disconnects, reactors, contactors, MCC bus and wiring only bays.

Frame 8 with Power Option Bay

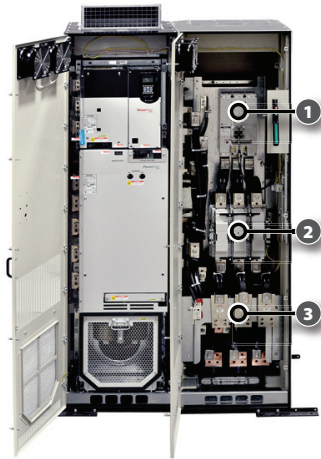

Input power landed on line-side of power disconnect.

Frame 9 with Power Option Bay

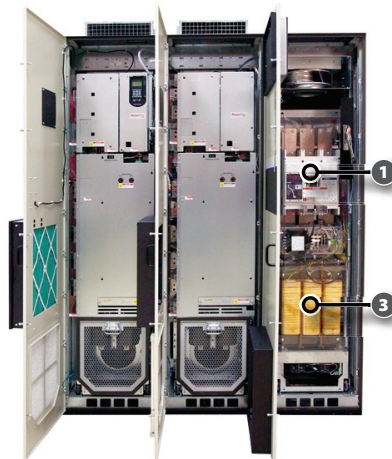

Input power landed behind circuit breaker, which is accessed by extracting roll-out chassis.

1. Power Disconnect Options -P3 or -P5
2. Contactor Options -P11 or -P12
3. Reactor Options -L1, -L2, -L3, or -L4

Approximate Dimensions and Weights Frames (1..7)

Dimensions are in mm (in.) - weights are in kg (lb)

IP00/IP20, NEMA/UL Type Open

Frame	H	W	D	Weight
1	400.5 (15.77)	110 (4.33)	211 (8.31)	6 (12.75)
2	424.2 (16.7)	134.5 (5.3)	212 (8.35)	7.8 (17.2)
3	454 (17.87)	190 (7.48)		11.8 (26.1)
4	474 (18.66)	222 (8.74)		13.6 (30)
5	550 (21.65)	270 (10.63)		20.4 (45)
6	665.5 (26.2)	308 (12.13)	346.4 (13.64)	38.6 (85)
7	881.5 (34.7)	430 (16.93)	349.6 (13.76)	72.6...108.9 (160...240)

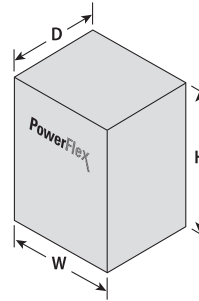

IP54, NEMA/UL Type 12

Frame	H	W	D	Weight
2	543.2 (21.39)	215.3 (8.48)	222.2 (8.75)	8 (17)
3	551 (21.69)	268 (10.55)	220.1 (8.67)	12 (26)
4	571 (22.48)	300 (11.81)		14 (30)
5	647 (25.47)	348.0 (13.7)		20 (45)
6	1298.3 (51.11)	609.4 (24)	464.7 (18.3)	91 (200)
7	1614 (63.54)			162 (357)

Flange Mount

Frame	H	W	D1	D2	Weight
2	481.8 (18.97)	206.2 (8.12)	148.3 (5.84)	63.7 (2.51)	8 (17)
3	515 (20.28)	260 (10.24)	127.4 (5.02)	84.6 (3.33)	12 (26)
4	535 (21.06)	292 (11.5)			14 (30)
5	611 (24.06)	340 (13.39)			20 (45)
6	665.5 (26.2)	308 (12.13)	208.4 (8.2)	138 (5.43)	38 (84)
7	875 (34.45)	430 (16.93)			96 (212)

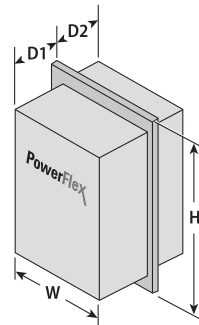

Approximate Dimensions and Weights Frames (8...10)

Dimensions are in mm (in.) - weights are in kg (lb)

IP20, NEMA/UL Type 1, MCC Style Cabinet

Frame	H	W	D	Weight
8	2453 (96.6)	600 (23.6)	600 (23.6) or 800 (31.5)	623 (1374)
8 with drive and options cabinet		1200 (47.2)		1145 (2525)
9		1200 (47.2)	600 (23.6) or 800 (31.5)	1246 (2748)
9 with drive and options cabinet		1800 (70.9)	800 (31.5)	2290 (5051)
10		1800 (70.9)	600 (23.6) or 800 (31.5)	1869 (4122)
10 with drive and options cabinet		2400 (94.5)	800 (31.5)	3435 (7576)

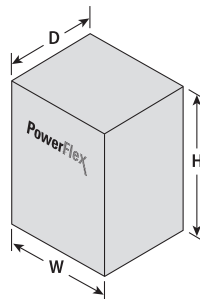

IP54, NEMA Type 12, MCC Style Cabinet

Frame	H	W	D	Weight
8	2477 (97.5)	600 (23.6)	800 (31.5) 898 (35.4) with filter	644 (1419)
8 with drive and options cabinet		1200 (47.2)		1166 (2570)
9		1200 (47.2)		1287 (2838)
9 with drive and options cabinet		1800 (70.9)		2332 (5141)
10		1800 (70.9)		1931 (4257)
10 with drive and options cabinet		2400 (94.5)		3498 (7711)

IP00, NEMA/UL Type Open

Frame	H	W	D
8	2145 (84.45)	778 (30.63)	425 (16.73)
9		1578 (62.12)	
10		2378 (93.62)	

Maximum Component Weights, Frames 8...10

Component	AC Input	Common DC Input
Converter/DC input with precharge	64 (140)	64 (140)
Inverter	222 (490)	165 (363)
Drive assembly (Open, IP00)	286 (630)	229 (504)

PowerFlex 755TL/TR AC Drives

7.5...4550 kW/10...6000 Hp from 400...690V

The new Allen-Bradley® PowerFlex 755TL and 755TR drives expand the proven PowerFlex 750 drive portfolio and provide solutions for harmonic mitigation and regeneration. The drives offer energy-saving features and a world-class footprint along with simplified installation and startup.

The new PowerFlex drives use TotalFORCE® technology to deliver exceptional motor control through precise, adaptive control of torque, velocity, and position. TotalFORCE technology incorporates several patented features that are designed to help optimize your system and maintain productivity through improved machine uptime.

PowerFlex 755TL/TR products have been enhanced to include XT corrosive gas protection, providing leading electronics reliability and suitability for industrial environments with corrosive atmospheres.

Attribute	Value	
Ratings	755TL	755TR
400V	7.5...1250 kW	7.5...3640 kW
480V	10...1800 Hp	10...6000 Hp
600V	10...1500 Hp	10...2500 Hp
690V	11...1400 kW	11...4596 kW
Motor Control	<ul style="list-style-type: none"> VHz Control Economizer Field-oriented Control Sensorless Vector Control Flux Vector Control 	<ul style="list-style-type: none"> Interior Permanent Magnet (IPM) Surface-mounted Permanent Magnet (SPM) Synchronous Reluctance (without Encoder) Voltage Boost
Enclosures	<ul style="list-style-type: none"> IP21, UL Type 1 	<ul style="list-style-type: none"> IP54, UL Type 12
Safety	<ul style="list-style-type: none"> Hardwired Safe Torque Off SIL 3, PLe, CAT 3 Hardwired Safe Speed Monitor SIL 3, PLe, CAT 4 	<ul style="list-style-type: none"> Networked Safe Torque Off SIL 3, PLe, CAT 3 Networked Integrated Safety Functions SIL 3, PLe, CAT 4
Additional Features	<ul style="list-style-type: none"> Regenerative power supply ride-through control reduces downtime TotalFORCE Technology Energy-efficient regenerative capability(1) Provides harmonic mitigation and power factor correction Optional built-in Dv/Dt filter designed to mitigate reflective wave phenomenon Modular construction for easy install and maintenance Built-in dual-port EtherNet/IP Predictive diagnostics help monitor drive components 	<ul style="list-style-type: none"> Embedded DeviceLogix™ control Adaptive tuning Bus Observer Load Observer LCL Filter Resonance and failure detection Auto Restart Start at power-up Emergency Override Energy Pause TorqProve™ Line voltage and current imbalance detection
Certifications	<ul style="list-style-type: none"> c-UL-us CE EAC KCC 	<ul style="list-style-type: none"> RCM RoHS WEEE <p>For a complete list, search PowerFlex Certifications on rok.auto/certifications</p>

Control and Power Options for PowerFlex 755TL and TR Drives

Pre-engineered, factory-installed options are available with the PowerFlex 755TL and 755TR drives.

For accessories and options, including HIMs and communication options, see PowerFlex 750-Series AC Drive Specifications Technical Data, 750-TD100.

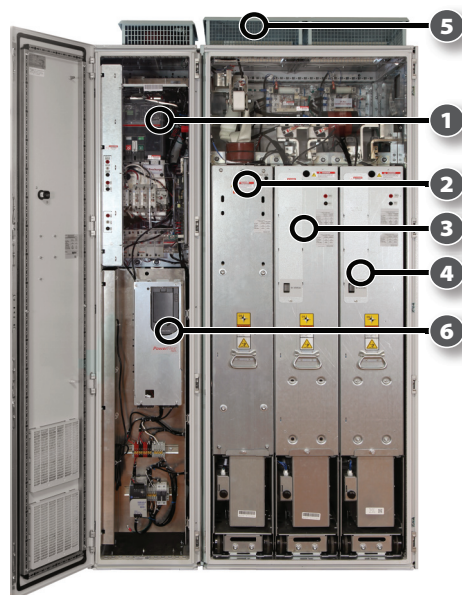

1. AC precharge
2. LCL Filter
3. Line Side Converter
4. Motor Side Inverter
5. IP21/IP54 Enclosures
6. Control Pod

PowerFlex 755TL AC Drive

The PowerFlex 755TL drive provides harmonic mitigation and power factor correction by using Regenerative Power Supply technology. By reducing the adverse effects of harmonic distortion, the drive helps to improve energy efficiency, reduce energy costs and minimize power distribution issues on the factory floor. In addition, new TotalFORCE technology delivers exceptional motor control through precise, adaptive control of torque, velocity, and position with patented features that are designed to help optimize your system and maintain productivity.

PowerFlex 755TM Drive Systems

PowerFlex 755TM drive systems enable coordination of multiple motors based on two main building blocks: regenerative common bus supplies and common bus inverters. For more information, see PowerFlex Common Bus Configuration Selection Guide, publication [DRIVES-SG001](#).

Catalog Number Explanation

Catalog number positions 1...7 identify the product type and voltage rating.



A

Drive		
Code	Type	Frames
20G	PowerFlex 755TL Drives	5...10
	PowerFlex 755TR Drives	5...15
	PowerFlex 755TM Common Bus Inverters	8...15
20J	PowerFlex 755TM Bus Supplies	6...15

B

Corrosive Gas Protection and Cooling Type		
Code	Description	Firmware
1	Standard Protection, Forced Air	Rev. 1.001 - 6.00x
E ⁽¹⁾	Corrosive Gas Protection (XT), Forced Air	Rev 10.001 and later

(1) Code E is a direct replacement of Code 1, providing backwards-compatible enhancements for reliability in corrosive gas environments.

C

Input Type		
Code	Description	Frames
6	Regenerative and Low Harmonic RPS, 755TR Drives	5...7
	Regenerative and Low Harmonic RPS, 755TM Bus Supplies	6...7
7	Low Harmonic regenerative power supply, 755TL Drives	5...7
D	Common Bus with DC Precharge	8...15
E	Common Bus without DC Precharge	8...15

PowerFlex 755TR AC Drive

The PowerFlex 755TR drive has built-in regeneration capability that helps reduce energy consumption by delivering regenerative energy from motors back to the incoming supply. Line regeneration can reduce the need for braking resistors and associated cooling equipment and helps avoid wasteful dissipation of energy. The drive also offers harmonic mitigation and the benefits of TotalFORCE technology and a world-class footprint and simplified startup and installation.

C

Input Type		
Code	Description	Frames
F	Regenerative and Low Harmonic RPS, 755TR Drives	8...15
	Regenerative and Low Harmonic RPS, 755TM Bus Supplies	8...15
G	Low Harmonic RPS, 755TL Drives	8...10

D

Enclosure		
Code	Description	Frames
N	IP00, UL Open Type	5...6
3	IP21, UL Type 1; Floor Mount	7...15
4	IP54, UL Type 12; Floor Mount	7...15

E

Voltage Rating	
Code	Voltage
C	400V AC; 3 PH
D	480V AC; 3 PH
E	600V AC; 3 PH
F	690V AC; 3 PH

Catalog number positions 8...10 identify the product normal duty rating.

1...3 4 5 6 7 8...10 11 12 13 14 15 16 17 18
 20G 1 G 3 D 740 L N A N N N N N -CO-P15...

F1...F4

F1

PowerFlex 755T ND Drive Ratings			
400V, 50 Hz Input			
Code	Amps	kW	Frame
015	15.4	7.5	5
022	22	11	
030	30	15	
037	37	18.5	
043	43	22	
060	60	30	
072	72	37	
085	85	45	
104	104	55	
140	140	75	
176	170	90	6
205	205	110	
260	260	132	
302	302	160	
367	367	200	
460	460	250	7
540	540	315	
585	600	315	
302	302	160	
367	367	200	
460	460	250	8
540	540	315	
585	585	315	
650	650	355	
750	750	400	
770	770	400	9
920	920	500	
1K0	1040	560	
1K1	1112	630	
1K2	1175	710	
1K4	1463	800	10
1K6	1590	850	
1K7	1715	1000	
2K1	2156	1250	
2K8	2849	1650	
3K5	3542	2000	12
4K2	4235	2200	13
5K6	5621	2920	14
7K0	7007	3640	15

F2

PowerFlex 755T ND Drive Ratings			
480V, 60 Hz Input			
Code	Amps	Hp	Frame
014	14	10	5
022	22	15	
027	27	20	
034	34	25	
040	40	30	
052	52	40	
065	65	50	
077	77	60	
096	96	75	
125	125	100	
156	156	125	6
186	186	150	
248	248	200	
302	302	250	
361	361	300	
430	430	350	7
505	505	400	
617	600	500	
302	302	250	
361	361	300	
430	430	350	8
505	505	400	
545	545	450	
617	617	500	
710	710	600	
740	740	650	9
800	800	700	
960	960	800	
1K0	1045	900	
1K1	1135	1000	
1K3	1365	1100	10
1K4	1420	1250	
1K6	1655	1500	
2K0	2072	1800	
2K6	2738	2400	
3K4	3404	3000	12
4K0	4070	3600	13
5K4	5402	4800	14
6K7	6734	6000	15

F3			
PowerFlex 755T ND Drive Ratings			
600V, 60 Hz Input			
Code	Amps	Hp	Frame
011	11	10	5
017	17	15	
022	22	20	
027	27	25	
032	32	30	
041	41	40	
052	52	50	
062	62	60	
077	77	75	
099	99	100	
125	125	125	6
144	144	150	
192	192	200	
242	242	250	7
295	295	300	
355	355	350	
395	395	400	
242	242	250	
295	295	300	
355	355	350	8
395	395	400	
435	435	450	
545	545	550	
595	580	600	9
690	690	700	
760	760	800	
825	825	900	
980	980	1000	
1K1	1045	1100	10
1K2	1220	1250	
1K5	1430	1500	
2K0	1946	2000	11
2K4	2420	2500	12
2K9	2998	3100	13
3K9	3979	4100	14
4K9	4960	5100	15

F4			
PowerFlex 755T ND Drive Ratings			
690V, 50 Hz Input			
Code	Amps	kW	Frame
015	15	11	5
020	20	15	
023	23	18.5	
030	30	22	
034	34	30	
046	46	37	
050	50	45	
061	61	55	
082	82	75	
098	98	90	
119	119	110	6
142	142	132	
171	171	160	
215	215	200	7
265	265	250	
330	330	315	
370	370	355	
215	215	200	
265	265	250	
330	330	315	8
370	370	355	
415	415	400	
505	505	500	
565	565	560	9
650	650	630	
735	735	710	
820	820	800	
920	920	900	
1K0	1030	1000	10
1K1	1150	1100	
1K4	1419	1400	
1K8	1865	1800	11
2K3	2318	2300	12
2K7	2778	2750	13
3K6	3687	3650	14
4K5	4596	4550	15

Catalog number positions 11...13 identify additional product configuration.

1...3 4 5 6 7 8...10 11 12 13 14 15 16 17 18
 20G 1 G 3 D 740 L N A N N N N N -C0-P15...
 I J K

I

Filtering and CM Cap Configuration

Code	EMC Filtering ⁽¹⁾	PE-A ⁽²⁾	PE-B	DR ⁽³⁾	Reflective Wave Filtering	Frames
J ⁽⁴⁾	Yes	Installed	Removed	–	No	8...15
K ⁽⁴⁾	Yes	Installed	Removed	–	Yes	8...15
L ⁽⁵⁾	No	Installed	Removed	Installed	No	5...15
M ⁽⁵⁾	No	Installed	Removed	–	Yes	8...15
P ⁽⁶⁾	Yes	Installed	Removed	–	No	7

- (1) EMC C2 ratings, conducted and radiated (IP54) or EMC C2 conducted only (IP21), are provided by 'P' filtering option for frame 7; C2 solutions kits are also available for frames 5, 6, and 8...10.
 (2) Configuration does not apply to product type 20G with input types D and E. PE-A jumpers are removed when bus conditioner for marine applications (-P51) is selected.
 (3) The DR jumper only applies to frame 5 and 6 drives.
 (4) Does not provide a C2 solution (C3 compliant), but does include some filtering.
 (5) C3 compliant without additional filtering.
 (6) Filtering with C2 compliance.

J

Dynamic Braking ⁽¹⁾

Code	Internal Resistor	Internal Transistor	Frames
N	No	No	5...15

- (1) Not available on Frames 8...15, specify Code 'N'.

K

Door-mounted HIM (Frames 7...15)

Code	Operator Interface and Control	Frames
A	No HIM with TotalFORCE Control	5...15
D	Enhanced LCD, Full Numeric, IP66, NEMA Type 4X/12 with TotalFORCE Control	7...15

Catalog number positions 14...18 are not used.

1..3	4	5	6	7	8...10	11	12	13	14	15	16	17	18	
20G	1	G	3	D	740	L	N	A	N	N	N	N	N	-CO-P15...

Power and control options are listed in the unnumbered field to right of position 18.

1..3	4	5	6	7	8...10	11	12	13	14	15	16	17	18	
20G	1	G	3	D	740	L	N	A	N	N	N	N	N	-CO-P15...

20G Control Options Selection

Code	Option	Frames	Input Type
C0	Torque Accuracy Module	5...12	D, E, F, G, 6, 7
		13...15	D, E
C11	Single Pod (with Control Bay) ⁽¹⁾	8...15	D, E
C12	Dual Pod (with Control Bay) ⁽¹⁾	8...15	D, E

(1) When code 'D' is selected in position 13, code C11 includes one door-mounted HIM and code C12 includes two door-mounted HIMs.

20J Control Options Selection

Code	Option	Frames	Input Type
C1	Control Transformer (Internal 240V) ⁽¹⁾	8...15	F

(1) This option only applies to 755TM regenerative and low harmonic bus supplies. If this option is not selected, a 240V AC, single-phase, neutral grounded external power source must be supplied by the customer.

20G Power Options Selection

Code	Option	Frames	Input Type
P15	Top Cable Exit with wiring bay	8...15	D, E, F, G
P16	Top Cable Entry with wiring bay	10...15	F, G
P17	Top Cable Entry no wiring bay	8...9	F, G
P46	System DC Bus (4700 Amp)	8...10	D, E, F, G
P50	DC Bus Conditioner	8...15	D, E, F, G
P51	DC Bus Conditioner - Marine Applications	8...15	D, E, F, G, 6, 7
P60	Back-to-back configuration	13...15	D, E, F, G

20J Power Options Selection

Code	Option	Frames	Input Type
P16	Top Cable Entry with wiring bay	10...15	F
P17	Top Cable Entry no wiring bay	8...9	F
P46	System DC Bus (4700 Amp)	8...10	F
P50	DC Bus Conditioner	8...15	F
P51	DC Bus Conditioner - Marine Applications	8...15	F

Approximate Dimensions and Weights

Frames 5...7

Frame Size	Input Voltage	Normal Duty Rating	Without Conduit Box				With Conduit Box			
			Width	Depth	Height	Weight	Width	Depth	Height	Weight
5	400	7.5...55 kW	343 (13.5)	356 (14)	863 (34)	85 (187)	343 (13.5)	356 (14)	1125 (44.3)	85 (187)
	480	10...60 Hp								
	600	10...50 Hp								
	690	11...55 kW								
6	400	75...132kW	404 (15.9)	361 (14.2)	1656 (65.2)	158 (349)	404 (15.9)	432 (17)	1877 (73.9)	158 (349)
	480	75...200 Hp								
	600	60...125 Hp								
	690	75...132 kW								
Frame Size	Input Voltage	Normal Duty Rating	IP21 Enclosure				IP54 Enclosure			
			Width	Depth	Height	Weight	Width	Depth	Height	Weight
7	400	160...315 kW	800 (31.5)	676 (26.6)	2131 (83.9)	596 (1315)	800 (31.5)	721 (28.4)	2291 (90.2)	596 (1315)
	480	250...500 Hp								
	600	150...400 Hp								
	690	160...355 kW								

Frames 8...12

Frame	Input Voltage	Normal Duty Rating	Width	Combined Width - Drive with Optional Wiring Bays			Depth		Height		Weight	
			Drive	With Entry Bay	With Exit Bay	With Both Bays	IP21	IP54	IP21	IP54	Without Filter	With Filter
8	400	160...400 kW	1200 (47.2)	(1)	1600 (63)	(1)	675 (26.6)	720 (28.3)	2132 (83.9)	2291 (90.2)	861.8 (1900)	920.8 (2030)
	480	250...650 Hp										
	600	250...550 Hp										
	690	200...500 kW										
9	400	400...800 kW	2000 (78.7)	(1)	2400 (94.5)	(1)	675 (26.6)	720 (28.3)	2132 (83.9)	2291 (90.2)	1360.8 (3000)	1419.7 (3130)
	480	650...1100 Hp										
	600	550...1000 Hp										
	690	500...900 kW										
10	400	800...1250 kW	3200 (126)	3600 (141.7)	3600 (141.7)	4000 (157.5)	675 (26.6)	720 (28.3)	2132 (83.9)	2291 (90.2)	2925.7 (6450)	3043.6 (6710)
	480	1100...1800 Hp										
	600	1000...1500 Hp										
	690	900...1400 kW										
11	400	1200...1650 kW	3800 (149.6)	4600 (181.1)	4600 (181.1)	5400 (212.6)	675 (26.6)	720 (28.3)	2132 (83.9)	2291 (90.2)	3447.3 (7600)	3565.2 (7860)
	480	1800...2400 Hp										
	600	1500...2000 Hp										
	690	1400...1800 kW										
12	400	1650...2000 kW	4600 (181.1)	5400 (212.6)	5400 (212.6)	6200 (244.1)	675 (26.6)	720 (28.3)	2132 (83.9)	2291 (90.2)	4286 (9450)	4463.3 (9840)
	480	2400...3000 Hp										
	600	2000...2500 Hp										
	690	1800...2300 kW										

(1) Optional wiring bay is not required for top entry of power cables.

Frames 13...15

Frame Size	Input Voltage	Normal Duty Rating	In-line Dimensions							Back to Back Dimensions								
			Length	Depth		Height		Square Footage (m ²)		Weight	Length (mm)	Depth (mm)		Height (mm)		Square Footage (m ²)		Weight
				IP21	IP54	IP21	IP54	IP21	IP54			IP21	IP54	IP21	IP54	IP21	IP54	
13	400	2200 kW	8000 (314.8)					5.41	5.77	6984 (15,397)	4000 (157.4)					5.41	5.77	7030 (15,498)
	480	3600 Hp																
	600	3100 Hp																
	690	2750 kW																
14	400	2920 kW	10,800 (425.2)	676 (26.6)	721 (28.4)	2132 (83.9)	2291 (90.2)	7.30	7.79	9122 (20,111)	5400 (212.6)	1352 (53.2)	1442 (56.8)	2132 (83.9)	2291 (90.2)	7.30	7.79	9098 (20,058)
	480	4800 Hp																
	600	4100 Hp																
	690	3650 kW																
15	400	3640 kW	12,400 (488.2)					8.65	9.23	10,842 (23,902)	6200 (244.1)					8.38	8.94	10,818 (23,850)
	480	6000 Hp																
	600	5100 Hp																
	690	4550 kW																

PowerFlex DC Drives

1.2...1044 kW/1.5...1400 Hp from 200...690V
Engineered solutions available up to 4000 kW / 6000 Hp

The PowerFlex DC drive combines powerful performance with flexible control to produce a highly functional, cost-effective drive and control solution. This drive also offers many features that allow the user to easily configure the drive for most application needs. Drive modules are available in IP20 Open Type enclosures, in both regenerative and non-regenerative configurations. The PowerFlex DC comes standard with an armature converter, regulated field converter for field weakening or economy applications, an advanced regulator with integrated DPI functionality, DC tachometer, and encoder capability.

Attribute	Value
Ratings	
200...240V	1.2...224 kW / 1.5...300 Hp / 7...1050 A
380...480V	1.5...671 kW / 2...900 Hp / 4.1...1494 A
500...600V	37...932 kW / 50...1250 Hp / 67.5...1688 A
690V	298...1044 kW / 400...1400 Hp / 452...1582 A
Motor Control	<ul style="list-style-type: none"> • Regenerative and Non-regenerative • Field Weakening and Economize
Enclosures	IP20, NEMA/UL Type Open
Additional Features	<ul style="list-style-type: none"> • Overload Protection • PID Control (Speed or Torque) • Adaptive Gain, Droop, Feedback Loss Switchover • TorqProve for lifting applications

1. LCD Numeric HIM shown (optional).
2. Multiple Communications options for industrial networks are available.
3. Embedded I/O: 8 digital inputs, 4 digital outputs, 3 analog inputs, 2 analog outputs, and 2 relay outputs.

For accessories and options, including HIMs and communication options, see PowerFlex DC Drive Specifications Technical Data, [20P-TD001](#).



PowerFlex DC Drive Catalog Number Explanation

1...3 4 5 6 7 8...10 11 12 13 14 15 16
20P **4** **1** **A** **D** **4P1** **R** **A** **O** **N** **N** **N**
 A B C D E F G H I J K L

A

Drive	
Code	Type
20P	PowerFlex DC drive
B	
Motor Operation	
Code	Type
2	Two quadrant operation ⁽¹⁾
4	Four quadrant operation
C	
Input Type	
Code	Type
1	6 pulse
D	
Enclosure	
Code	Enclosure Rating
A	IP20, NEMA/UL Type Open ⁽¹⁾

(1) Not available for 230V AC input drives.

(1) Conformal coated.

E

Input Voltage	
Code	Voltage
B	230V AC
D	460V AC ⁽¹⁾
E	600V AC
F	690V AC

(1) Use this code for 400V AC input applications.

F1

230V, 60 Hz Input					
Code	Hp	kW	Armature Amps	Frame	Field Amps
7P0	1.5	1.2	7	A	10
9P0	2	1.5	9		
012	3	2.2	12		
020	5	3.7	20		
029	7.5	5.5	29		
038	10	7.5	38		
055	15	11	55		
073	20	15	73		
093	25	18.5	93		
110	30	22	110		
146	40	30	146	B	20
180	50	37	180		
218	60	45	218		
265	75	56	265		
360	100	75	360		
434	125	93	434		
521	150	112	521		
700	200	149	700		
875	250	186	875		
1K0	300	224	1050		
1K0	300	224	1050	D	40

F2

460V, 60 Hz Input							
Code	Hp	kW	Armature Amps	Frame	Field Amps		
4P1	2	1.5	4.1	A	10		
6P0	3	2.2	6				
010	5	3.7	10				
014	7.5	5.5	14				
019	10	7.5	19				
027	15	11	27				
035	20	15	35				
045	25	18.5	45				
052	30	22	52				
073	40	30	73				
086	50	37	86	B	14		
100	60	45	100				
129	75	56	129				
167	100	75	167				
207	125	93	207				
250	150	112	250				
330	200	149	330				
412	250	187	412				
495	300	224	495				
667	400	298	667				
830	500	373	830	C	20		
996	600	447	996				
1K1	700	552	1162				
1K3	800	597	1328				
1K4	900	671	1494				
1K4	900	671	1494			D	40
1K4	900	671	1494			D	70

F3

575V, 60 Hz Input					
Code	Hp	kW	Armature Amps	Frame	Field Amps
067	50	37	67.5	B	20
101	75	56	101.3		
135	100	75	135		
270	200	149	270		
405	300	224	405		
540	400	298	540	C	40
675	500	373	675		
810	600	447	810		
1K0	800	597	1080		
1K2	900	671	1215		
1K3	1000	746	1350	D	40
1K6	1250	932	1668		

F4

690V, 60 Hz Input					
Code	Hp	kW	Armature Amps	Frame	Field Amps
452	400	298	452	C	20
565	500	373	565		
678	600	447	678		
791	700	552	791		
904	800	597	904		
1K0	900	671	1017	D	40
1K1	1000	746	1130		
1K2	1100	820	1243		
1K4	1250	932	1413		
1K5	1400	1044	1582		
1K5	1400	1044	1582	D	70

G

Field Supply	
Code	Type
R	Single-phase regulated

H

Packaging/Documentation	
Code	Type
A	Shipping carton and user manual

I

HIM	
Code	Operator Interface
O	Blank cover

J

I/O Options ⁽¹⁾	
Code	Control
N	None ⁽²⁾

- (1) All I/O options are purchased separately and user installed.
- (2) Eight 24V DC digital inputs, four digital outputs, three analog inputs, and two analog outputs are standard.

The PowerFlex DC Field Controller

The PowerFlex DC Field Controller provides three-phase, four quadrant (reversing) DC motor or generator field control. The PowerFlex DC Field Controller can be used for standalone DC motor field control applications, or with a PowerFlex DC Digital drive or PowerFlex DC Standalone Regulator (SAR). A fiber-optic interface option module, or digital and analog I/O, provides transmission of the reference, feedback, and status signals between the drive or regulator and the field controller.

In the standalone mode, the PowerFlex DC Field Controller provides power to a DC motor field with a fixed reference by using fixed I/O. The PowerFlex DC Field Controller can also be used to supply various DC non-motor loads (highly inductive loads). These DC non-motor loads include galvanic applications, electromagnets, synchronous motor excitation circuits, and others.

A PowerFlex DC field controller is a cost-effective way to modernize DC motor controls while using/re-purposing existing equipment.

Controller Features

- Programming flexibility allows parameters to be linked within the device.
- Field-flashable firmware through DPI interface.
- Reversing field supply standard on all frames.
- Controls non-motor inductive loads, such as electromagnets

The PowerFlex DC Standalone Regulator

The PowerFlex DC Standalone Regulator (SAR) and Gate Amplifier products provide an integrated solution to control external DC power modules. The SAR is a DC drive regulator that provides armature regulation, armature SCR gate signals and a regulated field supply. The SAR field supply consists of a single-phase, two quadrant (non-reversing) full wave rectified bridge, available as 40 amps or 70 amps. The SAR supports an AC line input voltage range of 230...690V AC and a field input voltage range of 100...460V AC.

Unsurpassed Capability in Network Communication

PowerFlex DC products are fully compatible with the wide variety of Allen-Bradley DPI communication adapters, which offer the following benefits:

BACnet	ControlNet	DeviceNet	EtherNet/IP	PROFIBUS	RS-485 DFI	Description
✓	✓	✓	✓			(Unconnected Messaging) permits other network devices (for example PanelView™) to communicate directly to a drive without routing the communication through the network scanner.
✓	✓	✓	✓		✓	Adapter Routing - Plug personal computer into one drive and talk to all other Allen-Bradley drives on same network, without being routed through network scanner.
✓	✓	✓	✓	✓	✓	Access to 100% of all parameters over the network.
✓		✓	✓	✓		Autobaud capability makes initial connections less problematic
		✓				Change of State significantly reduces network traffic by configuring control messages to be sent only upon customer defined states. Flexible configuration for each node (Example: "reference must change by more than 5%")
		✓	✓			Peer Control provides master-slave type control between drives. With this feature, one or more slave drives (consumers) can run based on the status of a master drive (producer). This feature can significantly reduce network traffic.
		✓				ADR (Automatic Device Replacement) saves significant time and effort when replacing a drive. The scanner can be configured to detect a new drive and download the required parameter settings
✓	✓	✓	✓	✓	✓	Flexible Fault Configuration - Adapters can be programmed to take fault-based actions, such as Ramp to Stop, and send user-configurable logic control and speed reference values. The drive can take different actions that are based on whether the network experienced a serious problem (broken cable, for example) versus network idle condition (controller set to "Program").

PowerFlex DC Field Controller Catalog Number Explanation

a		1...5 23PFC A		6 B B		7...9 245 C	
Drive		Input Voltage		DC Output			
Code	Type	Code	Voltage Range/Phase	Code	Amps	Frame Size	
23PFC	PowerFlex DC field controller	B	60...200V AC (±10%) / 3	017	17	A	
		D	230...500V AC (±10%) / 3	060	60	A	
				120	120	A	
				245	245	B	
				365	365	B	
				570	570	B	

Approximate Dimensions Frames (A...D)

Dimensions are in mm (in.)

PowerFlex DC Drives

Frame	H	W	D
A	359 (14.0)	267 (10.5)	287 (11.3)
B	388 (15.3)	311 (12.2)	350 (13.8)
C	511 (20.1)	521 (20.5)	416 (16.4)
D	1230 (48.4)	704 (27.7)	436.5 (17.2)

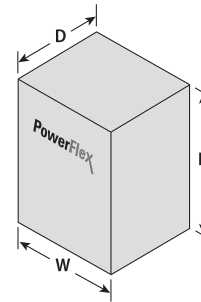

PowerFlex DC Field Controllers

Frame	H	W	D
A	359 (14.0)	267 (10.5)	287 (11.3)
B	388 (15.3)	311 (12.2)	350 (13.8)

Additional Resources

These documents contain additional information concerning related products from Rockwell Automation.

Resource	Description
PowerFlex 4M AC Drive Technical Data, 22F-TD001	Provides full product selection, accessories, dimensions, and specifications.
PowerFlex 400 AC Drive Technical Data, 22C-TD001	Provides full product selection, accessories, dimensions, and specifications.
PowerFlex 523 and 525 AC Drives Technical Data, 520-TD001	Provides full product selection, accessories, dimensions, and specifications.
PowerFlex 527 AC Drives Technical Data, 520-TD002	Provides full product selection, accessories, dimensions, and specifications.
PowerFlex 70 AC Drive Technical Data, 20A-TD001	Provides full product selection, accessories, dimensions, and specifications.
PowerFlex 753 AC Drive Technical Data, 750-TD001	Provides full product selection, accessories, dimensions, and specifications.
PowerFlex 755TL/TR/TM AC Drive Technical Data, 750-TD100	Provides full product selection, accessories, dimensions, and specifications.
PowerFlex DC Drive Technical Data, 20P-TD001	Provides full product selection, accessories, dimensions, and specifications.
EtherNet/IP Network Devices User Manual, ENET-UM006	Describes how to configure and use EtherNet/IP devices to communicate on the EtherNet/IP network.
Ethernet Reference Manual, ENET-RM002	Describes basic Ethernet concepts, infrastructure components, and infrastructure features.
System Security Design Guidelines Reference Manual, SECURE-RM001	Provides guidance on how to conduct security assessments, implement Rockwell Automation products in a secure system, harden the control system, manage user access, and dispose of equipment.
Industrial Components Preventive Maintenance, Enclosures, and Contact Ratings Specifications, publication IC-TD002	Provides a quick reference tool for Allen-Bradley industrial automation controls and assemblies.
Safety Guidelines for the Application, Installation, and Maintenance of Solid-state Control, publication SGI-1.1	Designed to harmonize with NEMA Standards Publication No. ICS 1.1-1987 and provides general guidelines for the application, installation, and maintenance of solid-state control in the form of individual devices or packaged assemblies incorporating solid-state components.
Industrial Automation Wiring and Grounding Guidelines, publication 1770-4.1	Provides general guidelines for installing a Rockwell Automation industrial system.
Product Certifications website, rok.auto/certifications .	Provides declarations of conformity, certificates, and other certification details.

You can view or download publications at rok.auto/literature.

Rockwell Automation Support

Use these resources to access support information.

Technical Support Center	Find help with how-to videos, FAQs, chat, user forums, and product notification updates.	rok.auto/support
Knowledgebase	Access Knowledgebase articles.	rok.auto/knowledgebase
Local Technical Support Phone Numbers	Locate the telephone number for your country.	rok.auto/phonesupport
Literature Library	Find installation instructions, manuals, brochures, and technical data publications.	rok.auto/literature
Product Compatibility and Download Center (PCDC)	Download firmware, associated files (such as AOP, EDS, and DTM), and access product release notes.	rok.auto/pcdc

Documentation Feedback

Your comments help us serve your documentation needs better. If you have any suggestions on how to improve our content, complete the form at rok.auto/docfeedback.

Allen-Bradley, ArmorBlock, CENTERLINE, CompactLogix, Connected Components Workbench, DeviceLogix, expanding human possibility, GuardLogix, Guardmaster, Kinetix, PanelView, POINT I/O, PowerFlex, QuickView, Rockwell Automation, SensaGuard, Stratix, Studio 5000, Studio 5000





Logix Designer, TorqProve, TotalForce and Zero-Stacking Drives are trademarks of Rockwell Automation.

ControlNet, DeviceNet and EtherNet/IP are trademarks of ODVA, Inc.

Trademarks not belonging to Rockwell Automation are property of their respective companies.

Rockwell Automation maintains current product environmental compliance information on its website at rok.auto/pec.

Rockwell Otomasyon Ticaret A.Ş. Kar Plaza İş Merkezi E Blok Kat:6 34752, İçerenköy, İstanbul, Tel: +90 (216) 5698400 EEE Yönetmeliğine Uygundur

Connect with us.    

rockwellautomation.com ————— expanding **human possibility**[™]

AMERICAS: Rockwell Automation, 1201 South Second Street, Milwaukee, WI 53204-2496 USA, Tel: (1) 414.382.2000, Fax: (1) 414.382.4444

EUROPE/MIDDLE EAST/AFRICA: Rockwell Automation NV, Pegasus Park, De Kleetlaan 12a, 1831 Diegem, Belgium, Tel: (32) 2 663 0600, Fax: (32) 2 663 0640

ASIA PACIFIC: Rockwell Automation, Level 14, Core F, Cyberport 3, 100 Cyberport Road, Hong Kong, Tel: (852) 2887 4788, Fax: (852) 2508 1846